

4532897COM Fireplace console-Persian oak

Ameriwood
HOME

Date of Purchase ___/___/___
Lot Number:

B344532897COM00KX

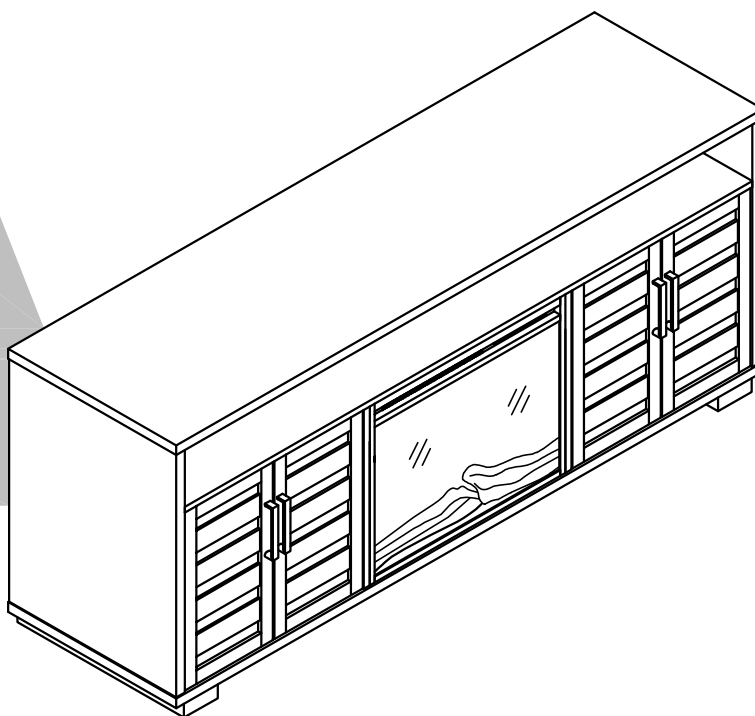

THIS INSTRUCTION BOOKLET CONTAINS **IMPORTANT** SAFETY INFORMATION. PLEASE READ AND KEEP FOR FUTURE REFERENCE.

Do Not Return This Product!

Contact our customer service team for help first.

Call: 1-800-489-3351 (toll free)

Monday-Friday 9am - 5pm CST

Visit: www.ameriwoodhome.com

WARNING

- Unit can tip over causing severe injury or death.
- Anchor unit to stud in wall (if instructed to).
- Do Not allow children to climb on unit.
- Put heavy items on lower shelves or drawers.



Follow Ameriwood Home



Contact Us!

Do NOT return this product!

Contact our friendly customer service team first for help.

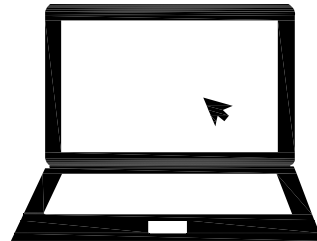

Visit ameriwoodhome.com

Assembly Tips



Helpful Hints

PEOPLE NEEDED FOR ASSEMBLY: 2

ESTIMATED ASSEMBLY TIME: 1.5-2.0 HOUR

- Open your item in the area you plan to keep it to avoid excessive heavy lifting.
- Identify, sort and count the parts before attempting assembly.
- Compression dowels are lightly tapped in with a hammer.
- Slides are labeled with a R (right) and L (left) for proper placement.
- Make sure to always face the point on the top of the Cam Lock towards the outer edge.
- Use all the nails provided for the back panel and spread them out equally.
- Back panel must be used to make sure your unit is sturdy.
- Do NOT use harsh chemicals or abrasive cleaners on this item.
- Never push, pull, or drag your furniture.



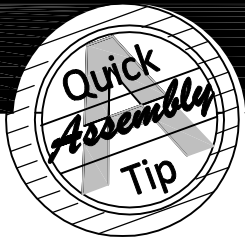

Before You Start

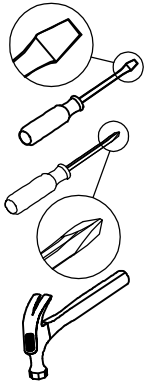

- ✓ Read through each step carefully and follow the proper order
- ✓ Separate and count all your parts and hardware
- ✓ Give yourself enough room for the assembly process
- ✓ Have the following tools: Flat Head Screwdriver, #2 Phillips Head Screwdriver and Hammer
- ✓ Caution: If using a power drill or power screwdriver for screwing, please be aware to slow down and stop when screw is tight. Failure to do so may result in stripping the screw.

Cam Lock Fastening System

This Cam Lock Fastening System will be used throughout the assembly process.

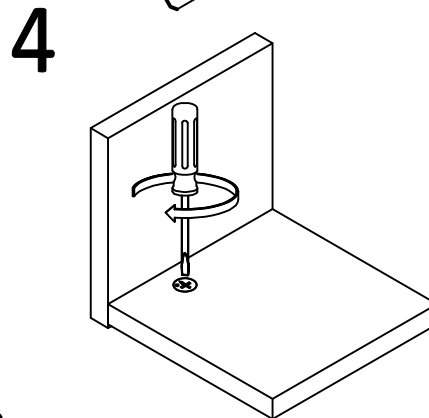
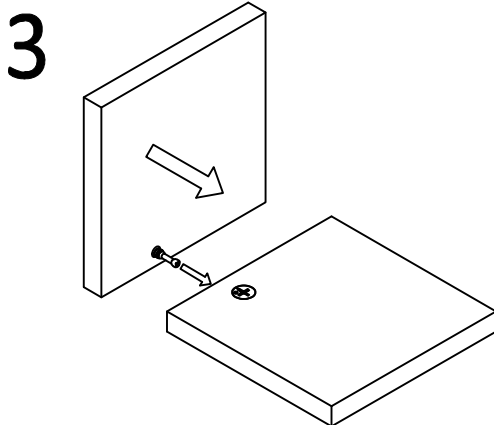
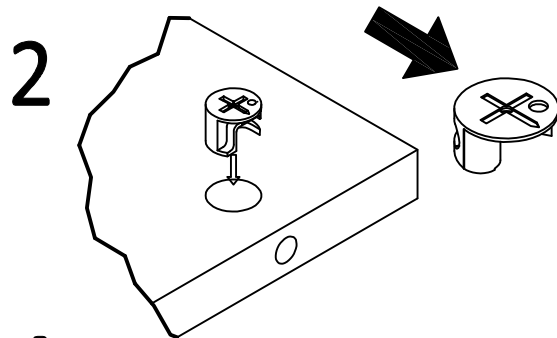
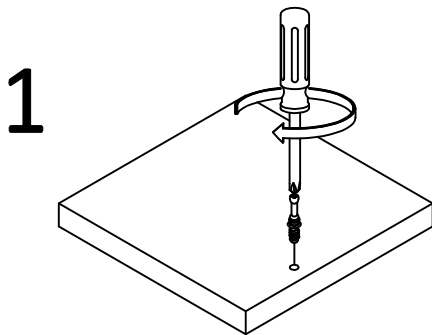

Board Identification

Not Actual Size

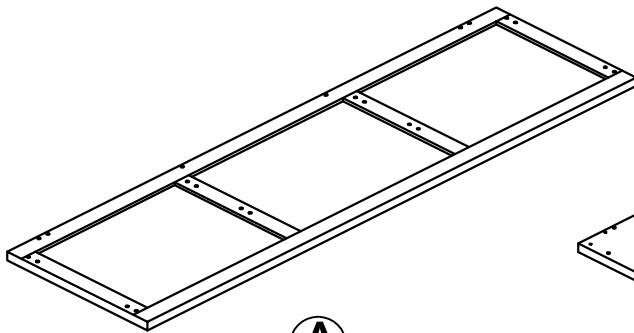

A

Top panel
T4532897010KX

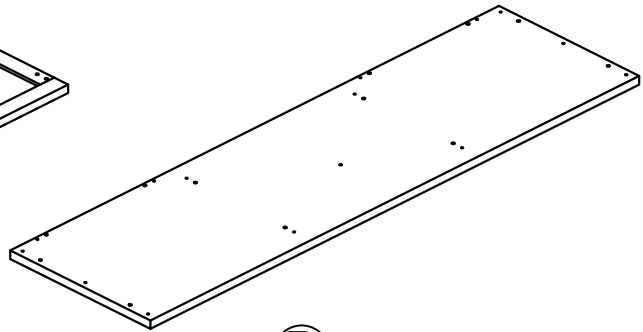

B

Bottom panel
T4532897020KX

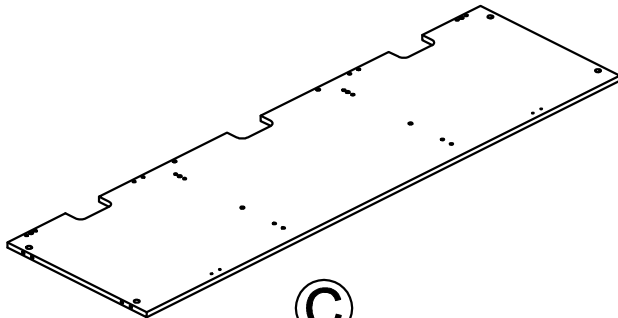

C

Fixed shelf
T4532897030KX

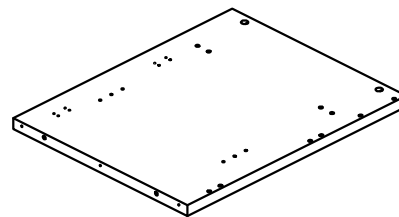

D

Left side panel
T4532897040KX

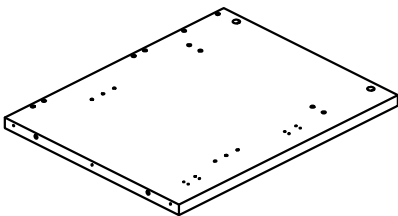

E

Right side panel
T4532897050KX

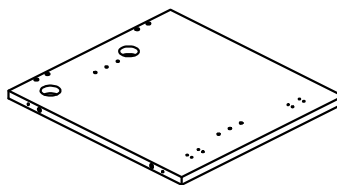

F

Left lower partition
T4532897060KX

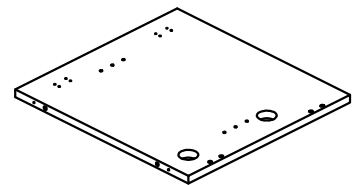

G

Right lower partition
T4532897070KX

Board Identification

Not Actual Size

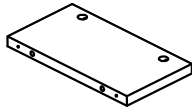

(H)
Upper partition
T4532897080KX
QTY:2PCS

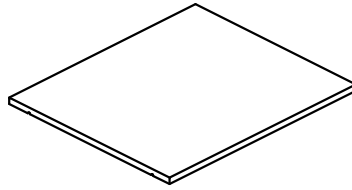

(I)
Shelf
T4532897090KX
QTY:2PCS

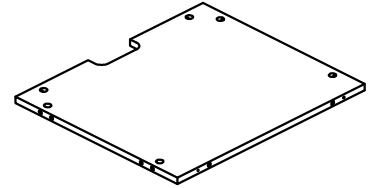

(J)
Lower back panel
T4532897100KX
QTY:2PCS

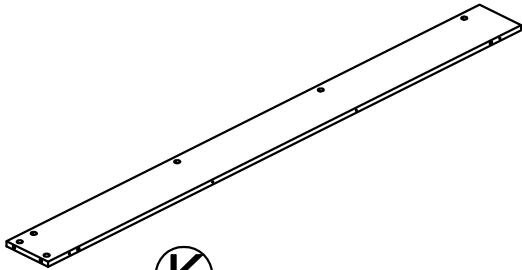

(K)
Upper back panel
T4532897110KX

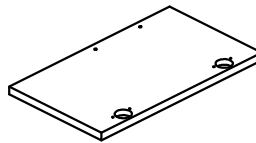

(L)
Left door
T4532897120KX
QTY:2PCS

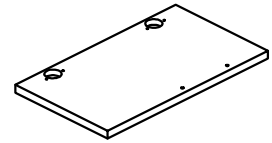

(M)
Right door
T4532897130KX
QTY:2PCS

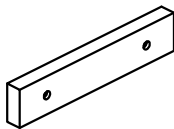

(N)
Leg
T4532897140KX
QTY:2PCS



(O)
Center leg
T4532897150KX
QTY:2PCS

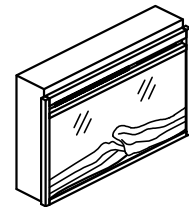

(P)
Fireplace
RV23P80L

Board Identification

Not Actual Size

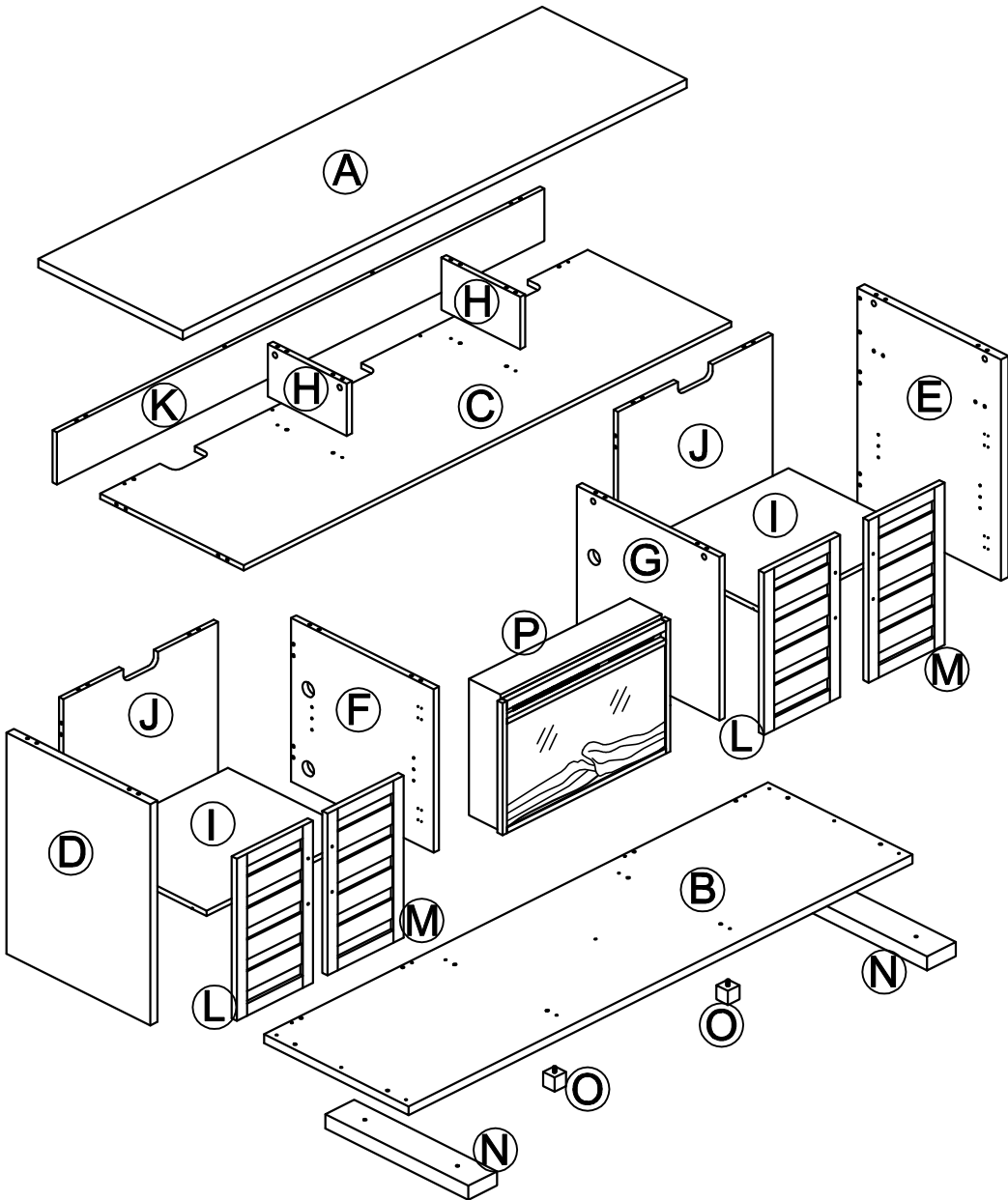

Part List

Actual Size

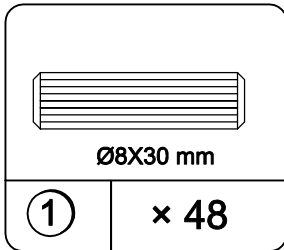

Wood dowel
TKX1005

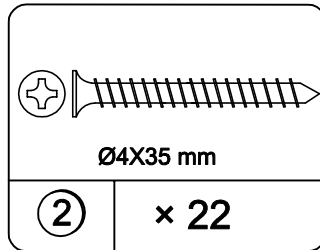

Screw
TKX1068

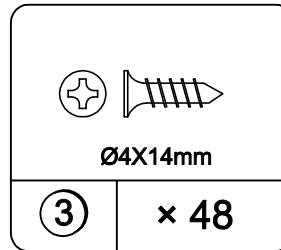

Screw
TKX1374

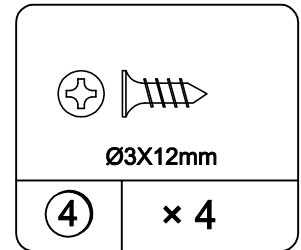

Screw
TKX1300

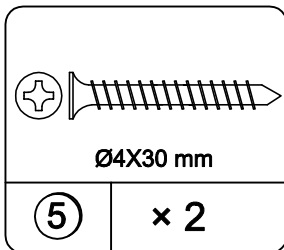

Screw
TKX1411

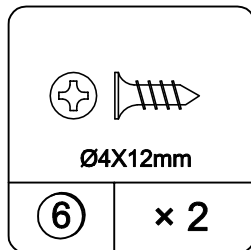

Screw
TKX1451

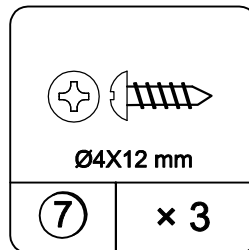

Screw
TKX1168

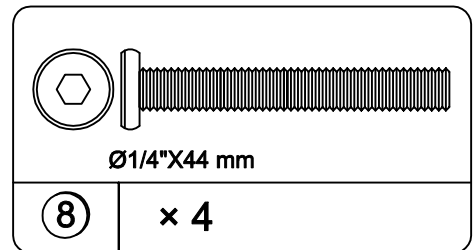

Bolt
TKX1162

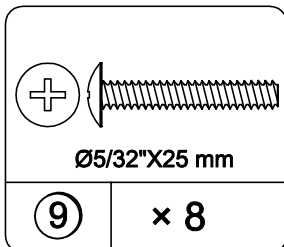

Screw bolt
TKX1046

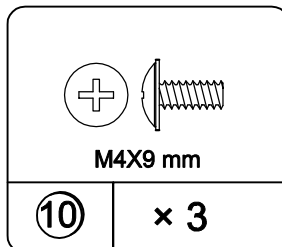

Screw bolt
TKX1447

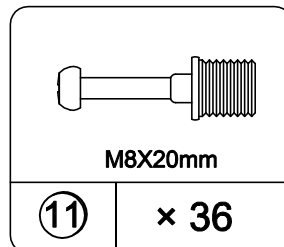

Cam bolt
TKX1191

Part List

Not Actual Size

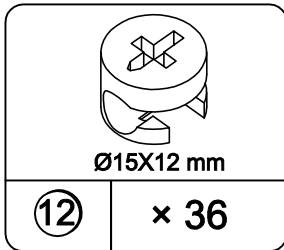

Cam lock
TKX1022

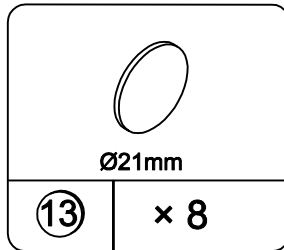

Cam cover
TKX1449

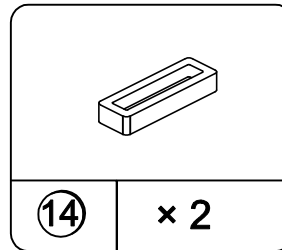

Door stop
TKX1392

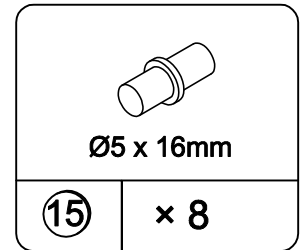

Shelf support
TKX1174

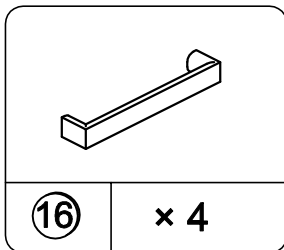

Handle
TKX1450

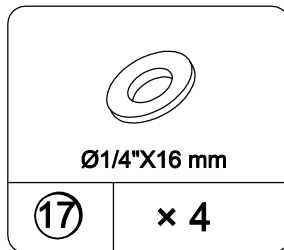

Washer
TKX1003

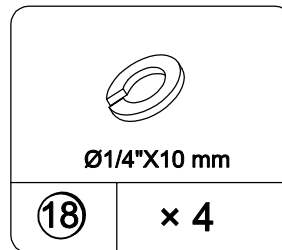

Spring washer
TKX1002

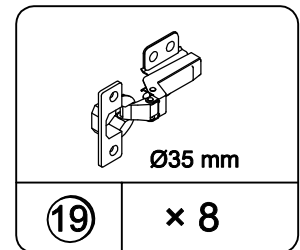

Euro hinge
TKX1084

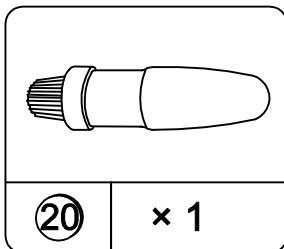

Glue
TKX1014

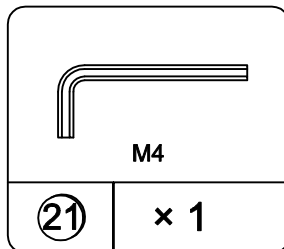

Hex key
TKX1004

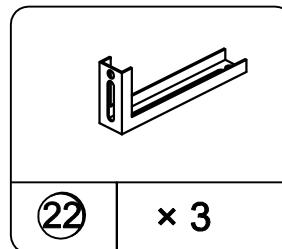

Bracket
TKX1430

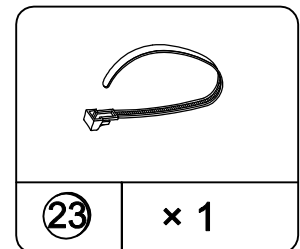

Strap
TKX1448

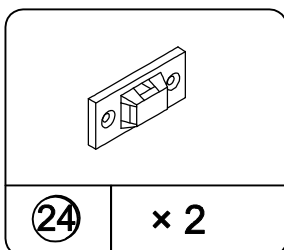

Clip
TKX1061

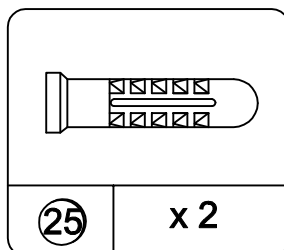

Wall anchor
TKX1042

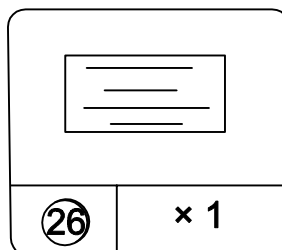

Warning label
TKX3006

STEP 1

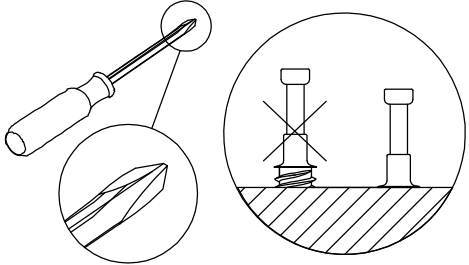
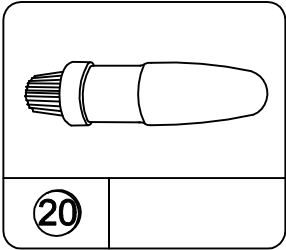
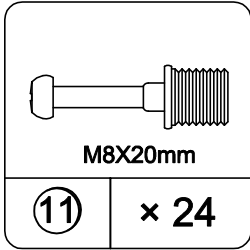
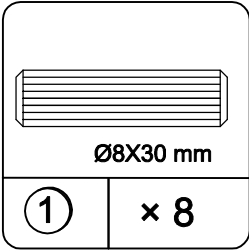

- 1.1 Attach (11) to (A),(D) & (E) as illustrated.
- 1.2 Attach (1) to (D) & (E) as illustrated.

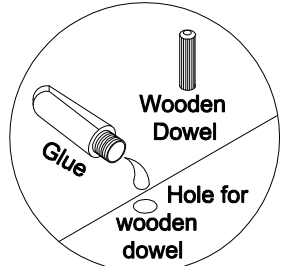

Use one drop of glue in dowel hole.

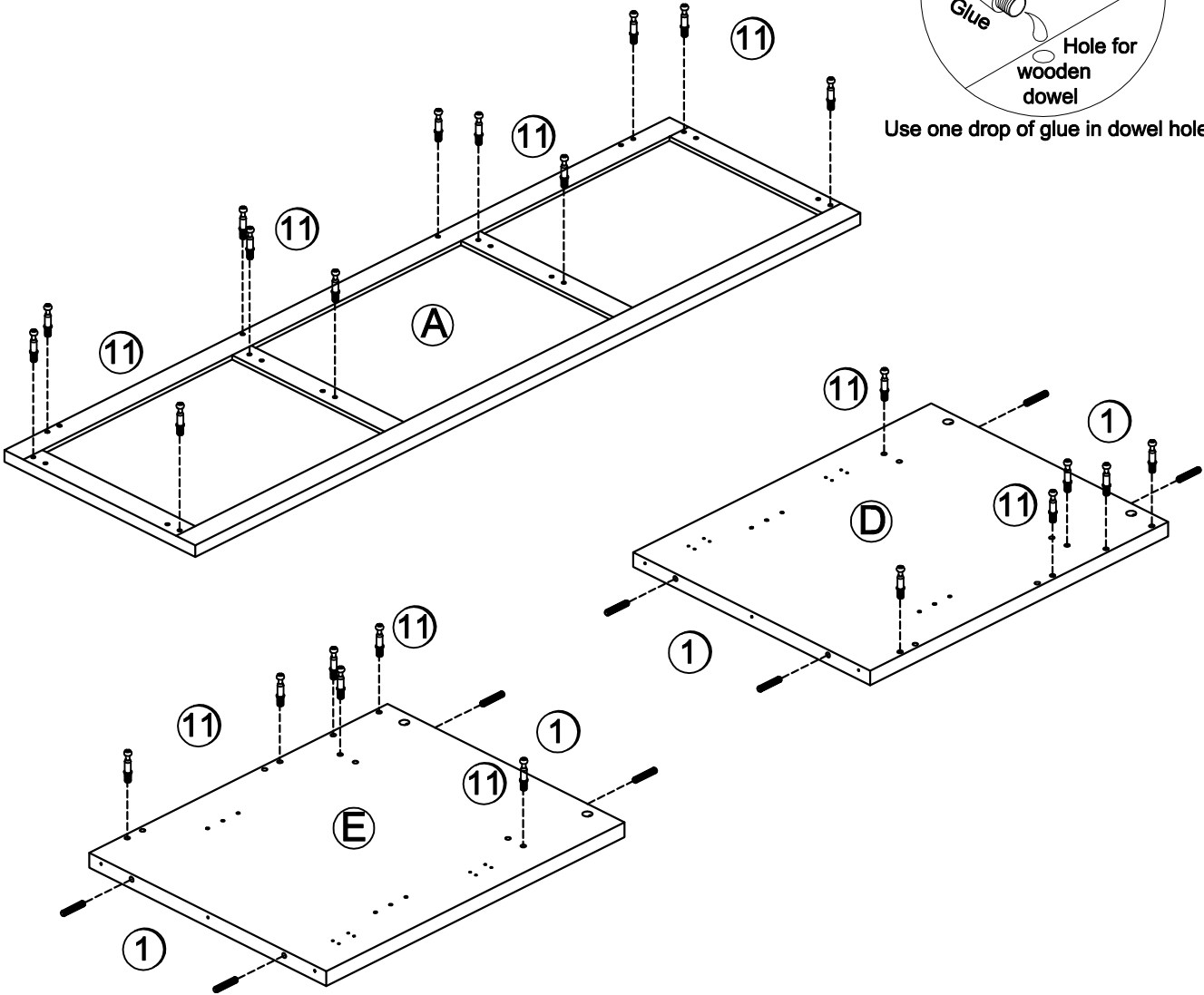

STEP 2

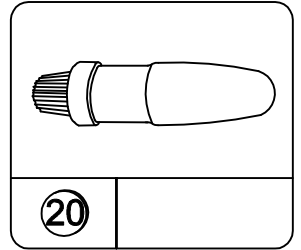
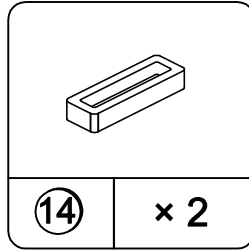
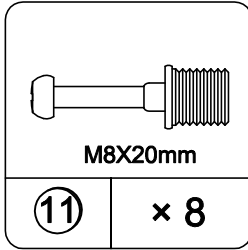
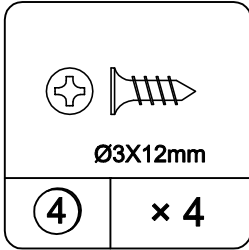
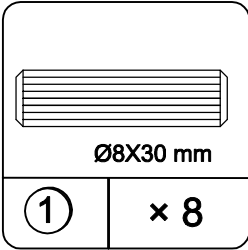

- 2.1 Attach (14) to (C) with (4) as illustrated.
- 2.2 Attach (11) to (C) as illustrated.
- 2.3 Attach (1) to (C) & (K) as illustrated.

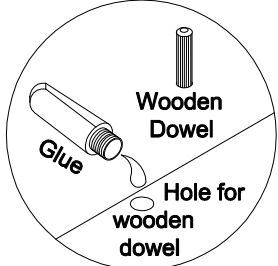
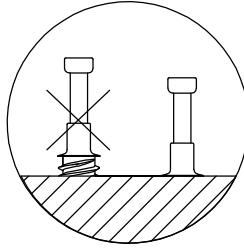

Use one drop of glue in dowel hole.

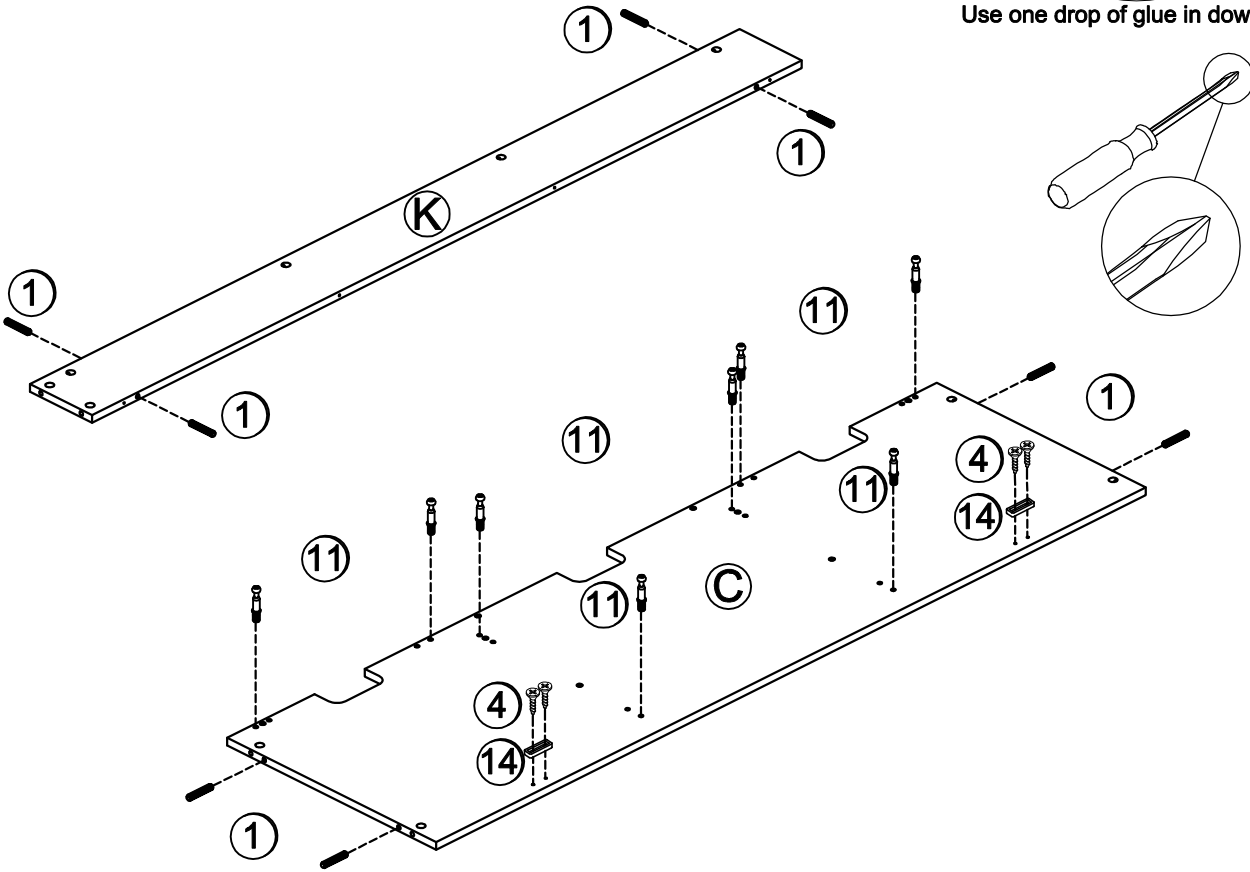

STEP 3

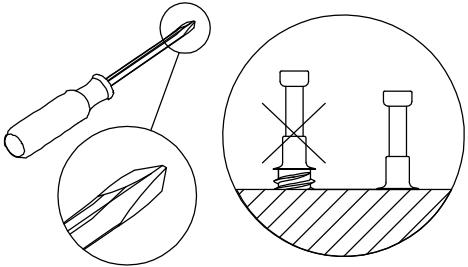
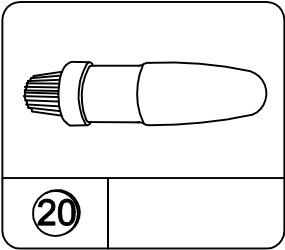
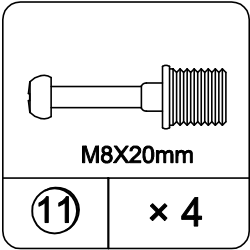
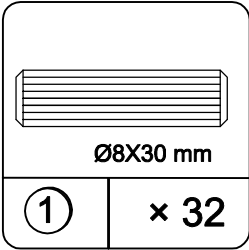

- 3.1 Attach (11) to (F) & (G) as illustrated.
- 3.2 Attach (1) to (F),(G),(H) & (J) as illustrated.

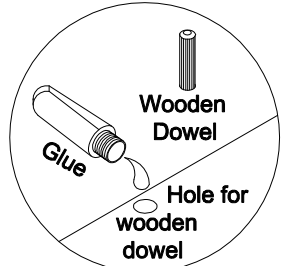

Use one drop of glue in dowel hole.

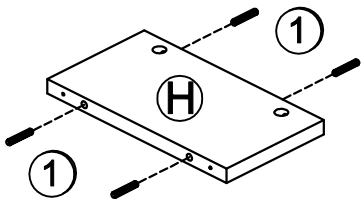
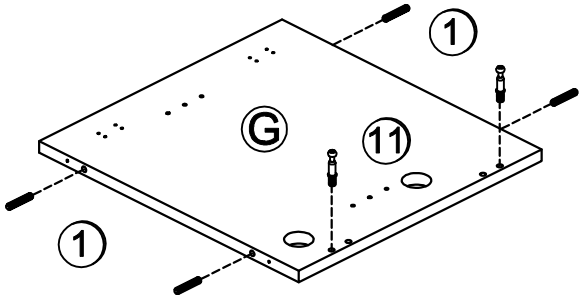
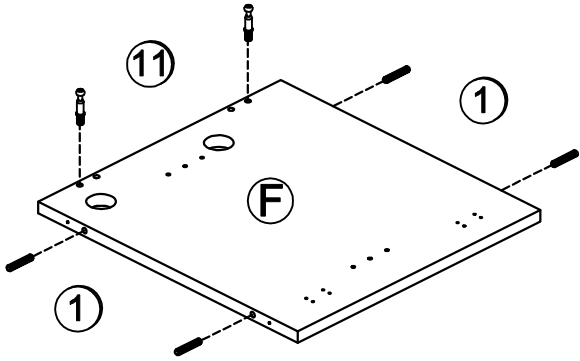

× 2

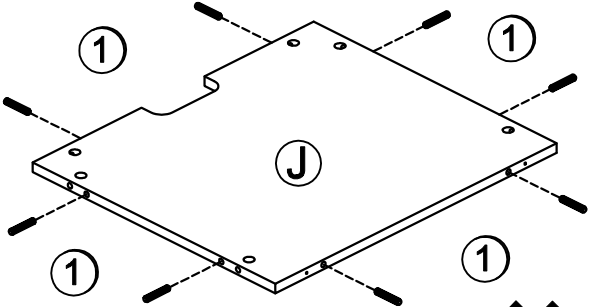

× 2

STEP 4

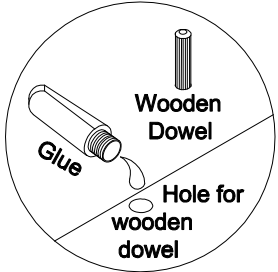
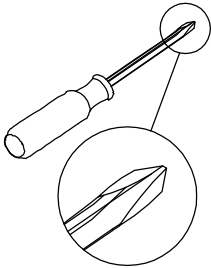
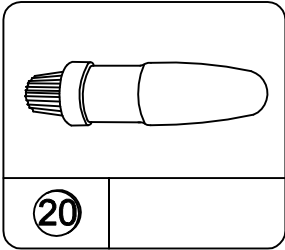
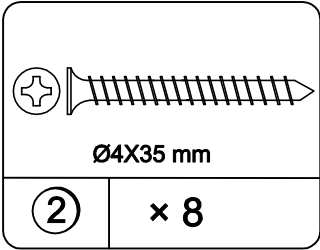

Use one drop of glue in dowel hole.

4.1 Attach (H),(K) to (C) with (2) as illustrated.

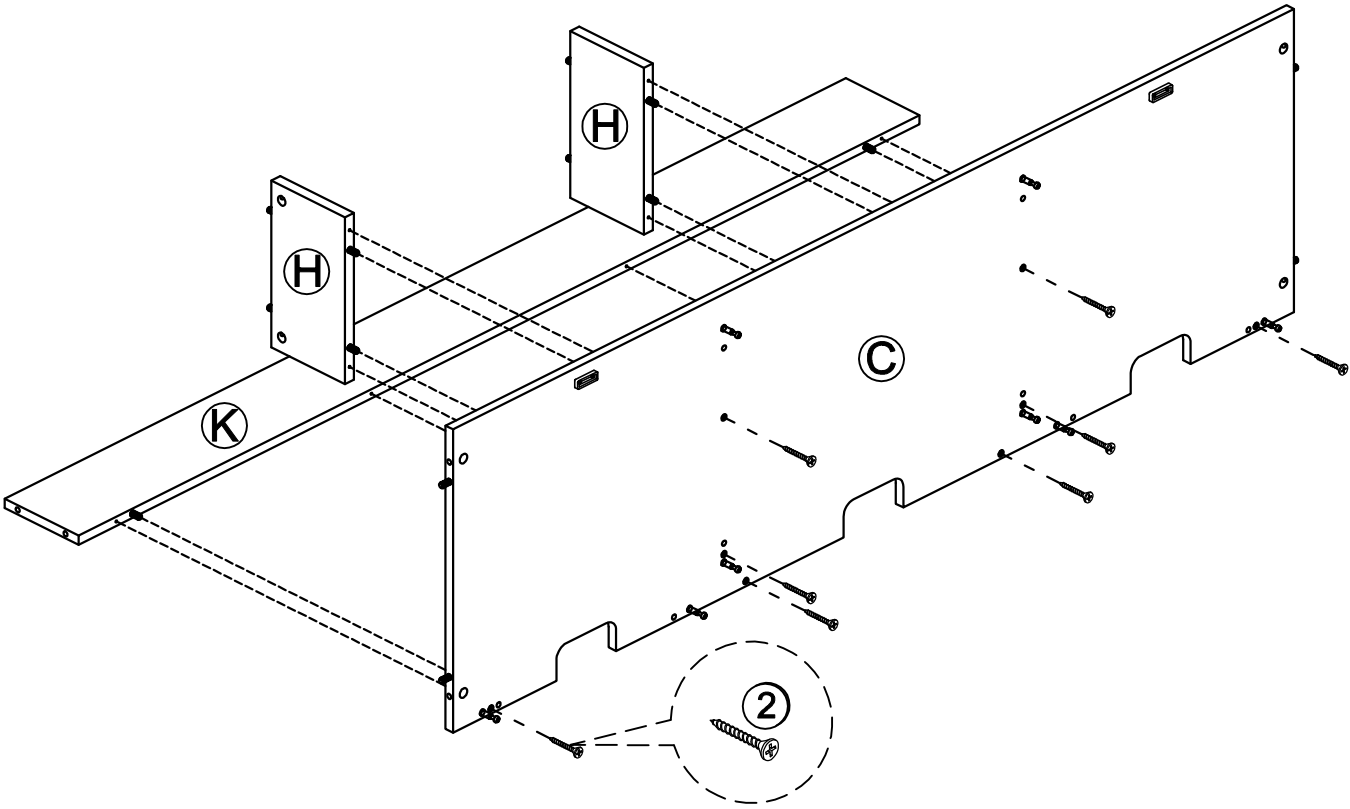

STEP 5

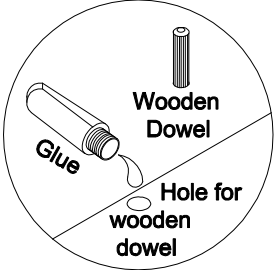
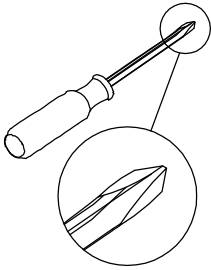
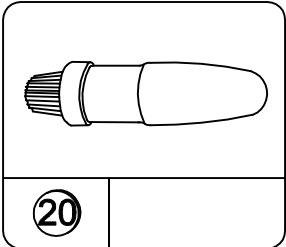
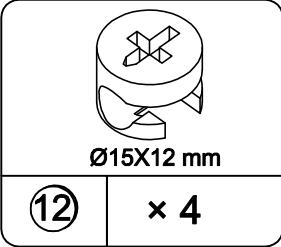

Use one drop of glue in dowel hole.

5.1 Attach (J) to (F) & (G) with (12) as illustrated.

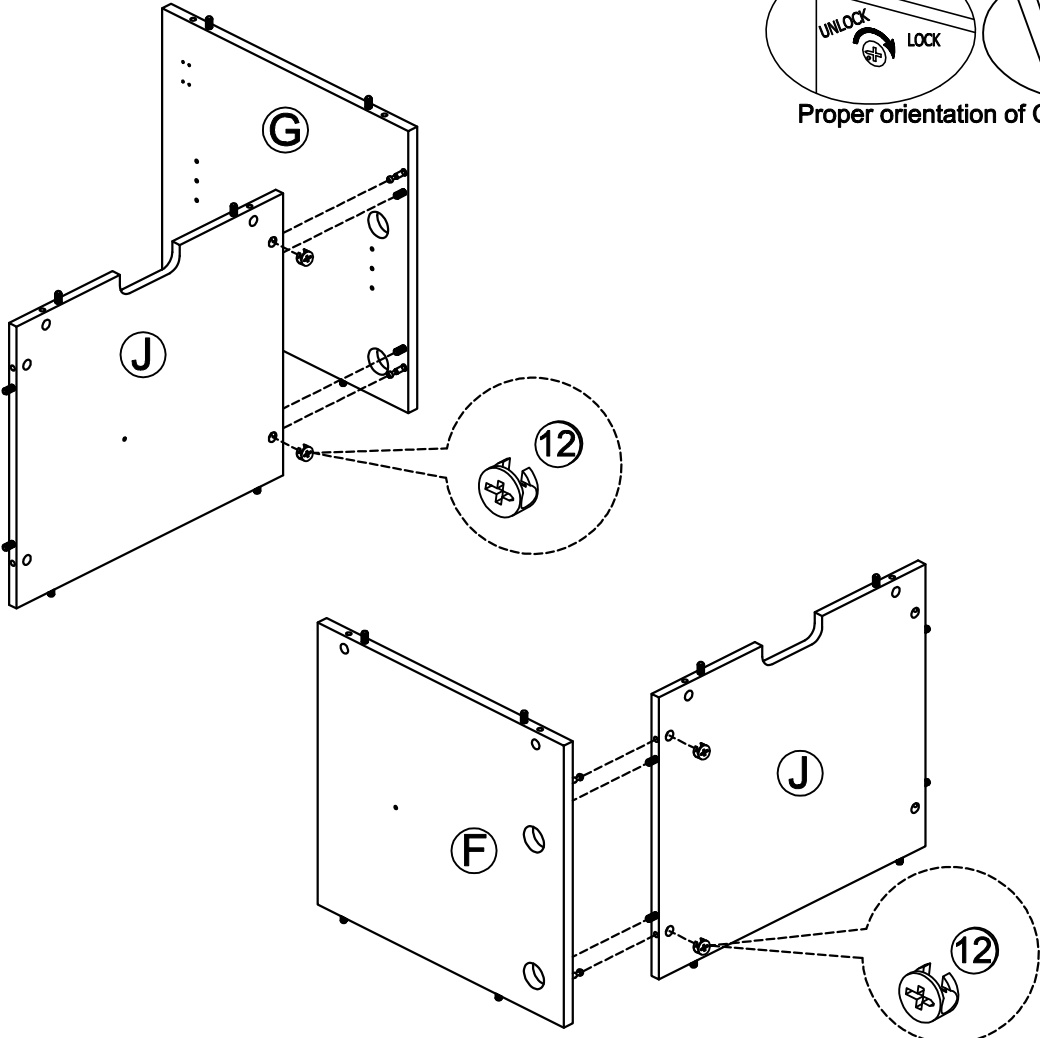
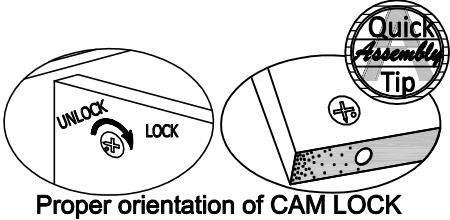

STEP 6

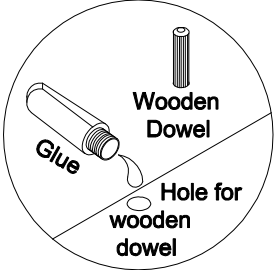
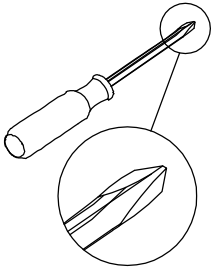
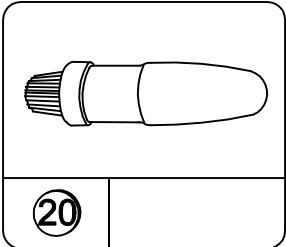
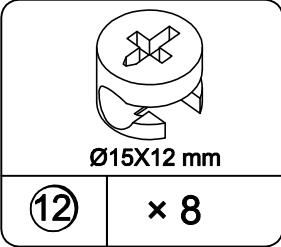

Use one drop of glue in dowel hole.

6.1 Attach (F),(G),(J) to (C) with (12) as illustrated.

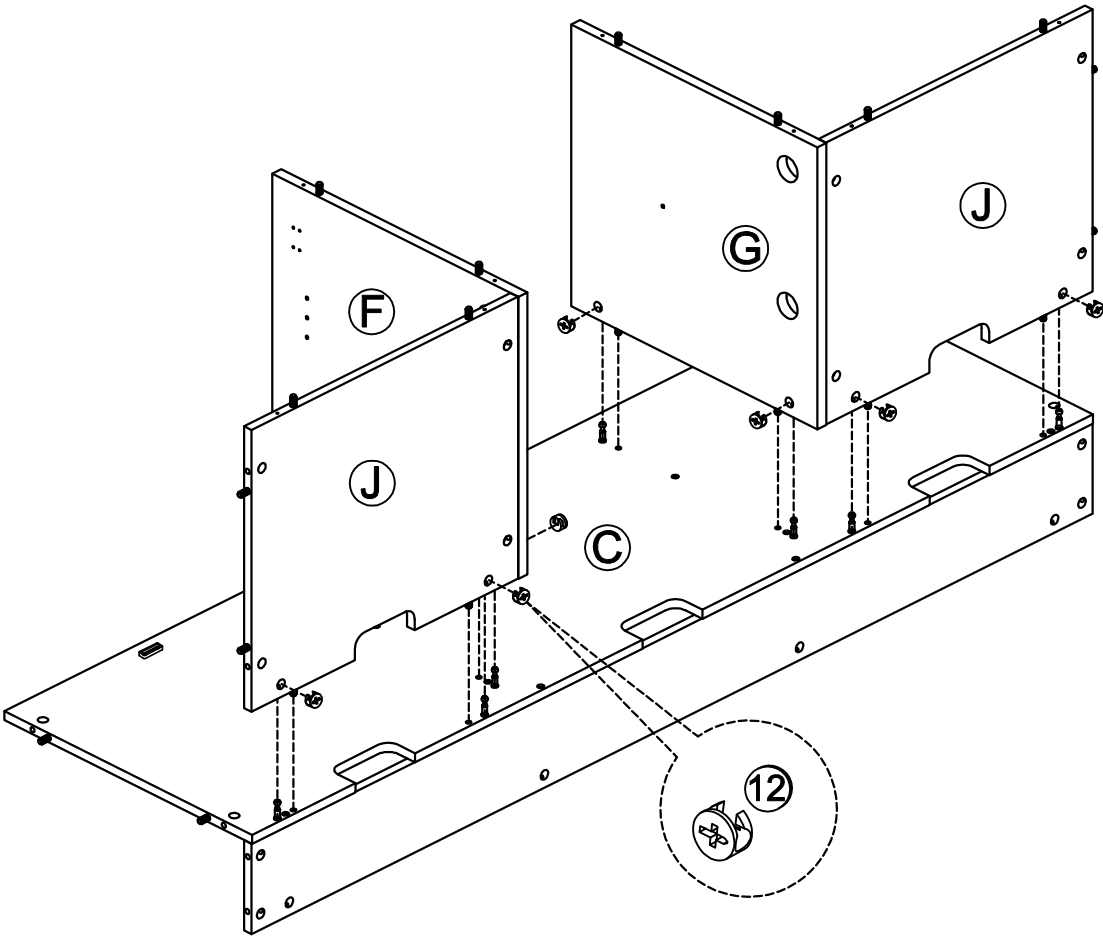
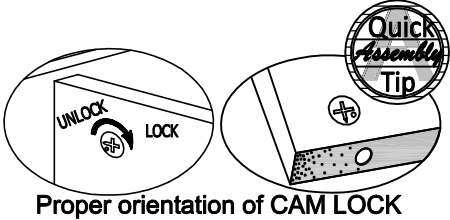

STEP 7

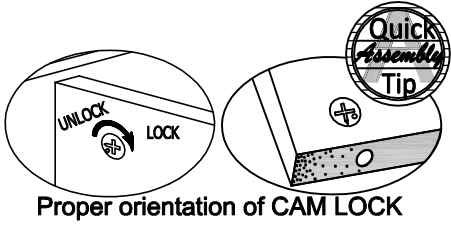
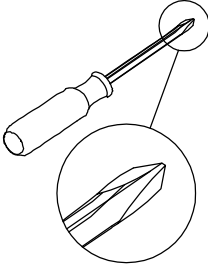
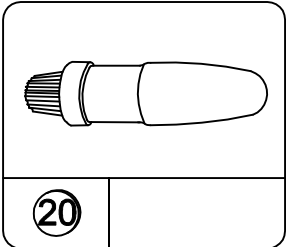
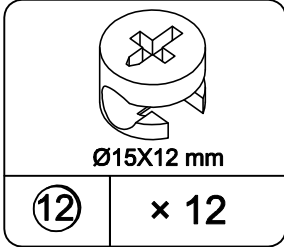

7.1 Attach (D) & (E) to sample from previous step with (12) as illustrated.

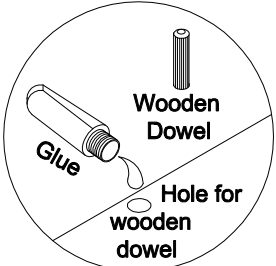

Use one drop of glue in dowel hole.

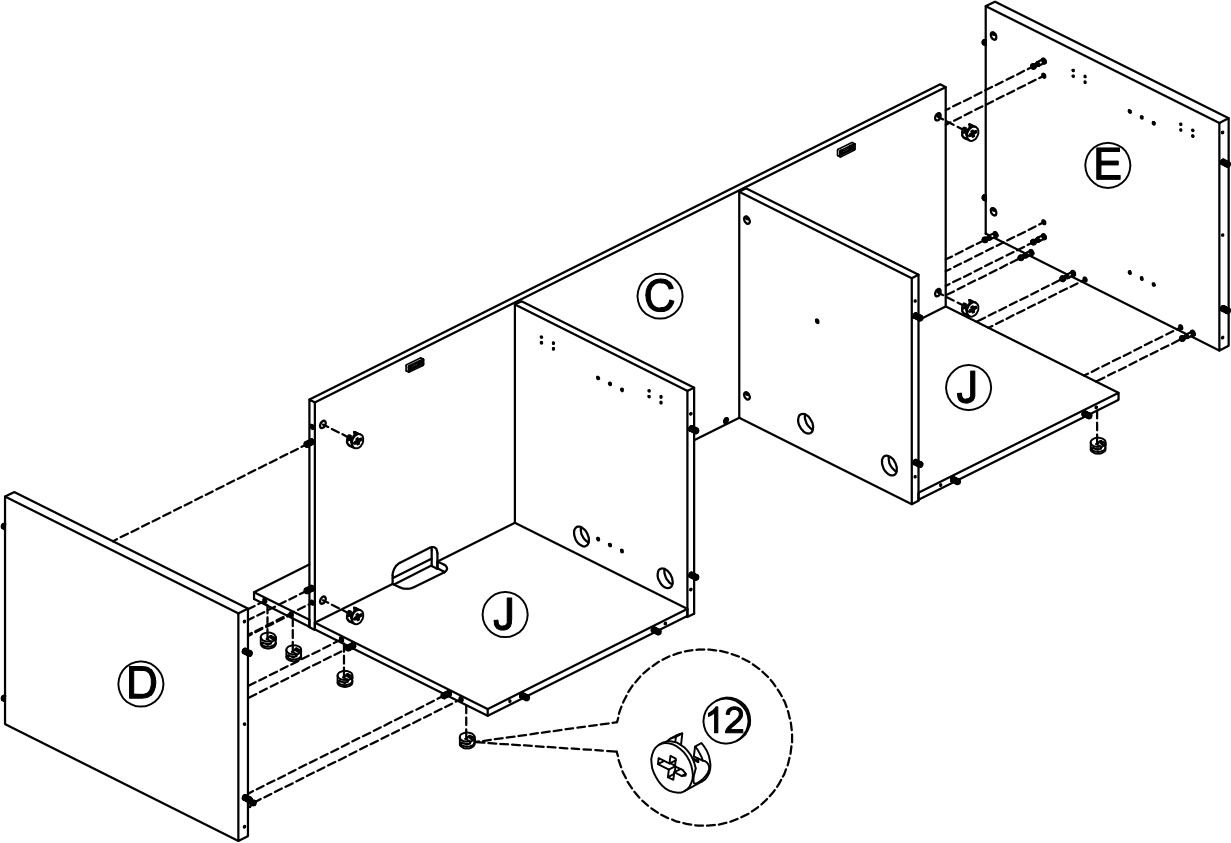

STEP 8

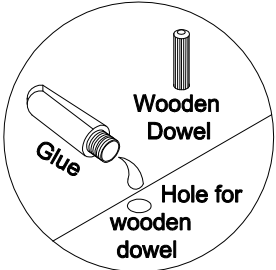
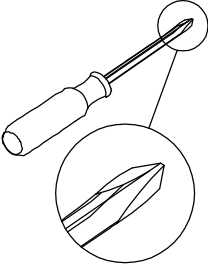
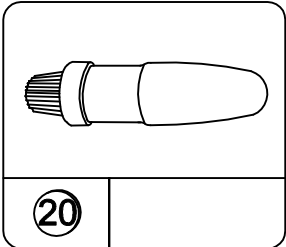
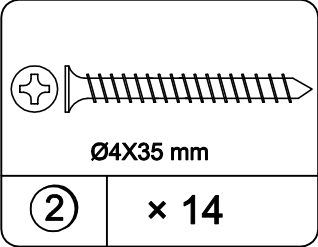

Use one drop of glue in dowel hole.

8.1 Attach (B) to sample from previous step with (2) as illustrated.

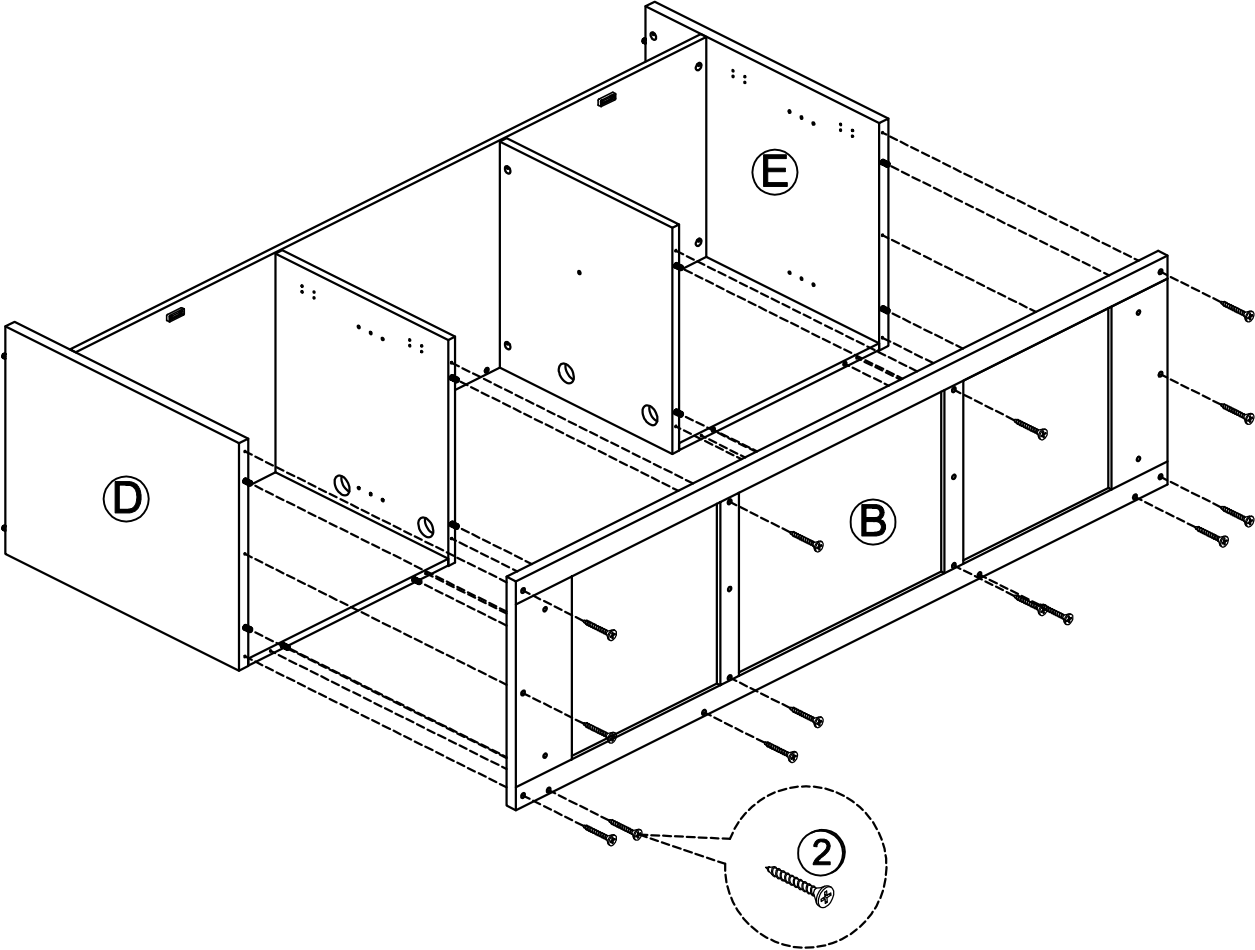

STEP 9

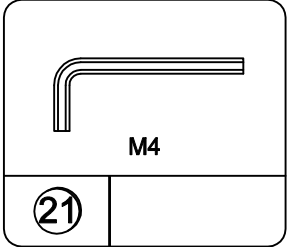
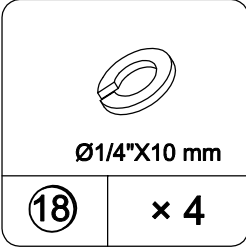
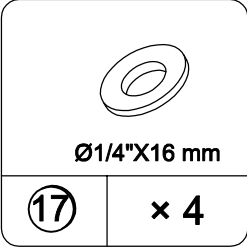
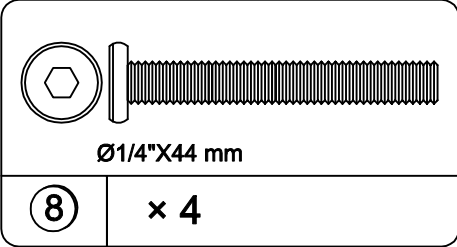

- 9.1 Attach (O) to (B) as illustrated.
- 9.2 Attach (N) to (B) with (8), (18), (17) as illustrated.

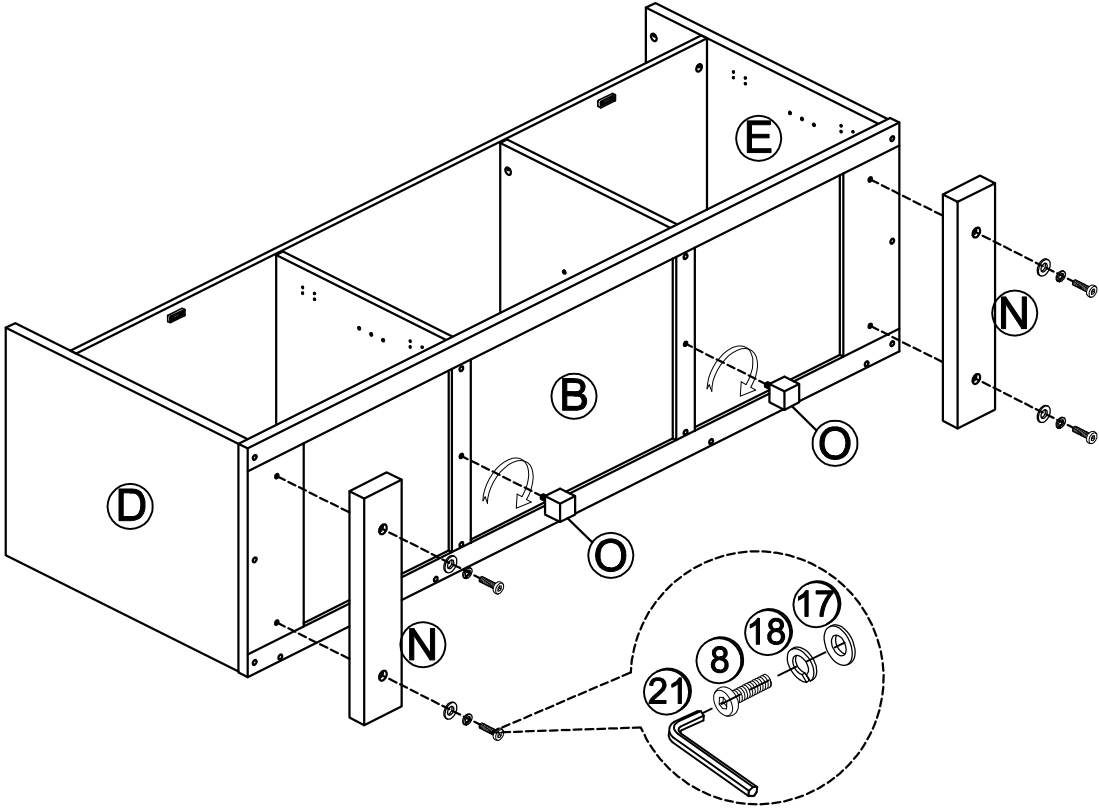

STEP 10

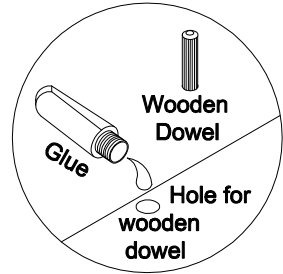
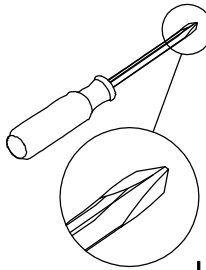
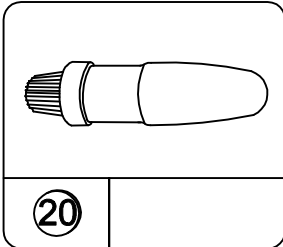
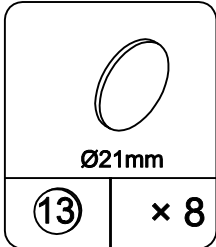
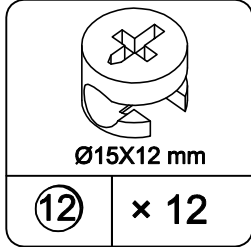

Use one drop of glue in dowel hole.

10.1 Attach (D), (E), (H), (K) to (A) with (12) as illustrated.

10.2 Use (13) to cover cam lock holes as illustrated.

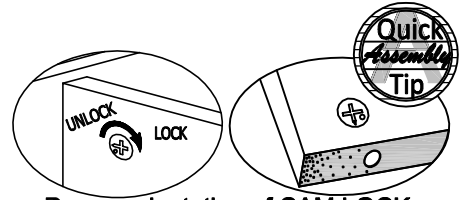

Proper orientation of CAM LOCK

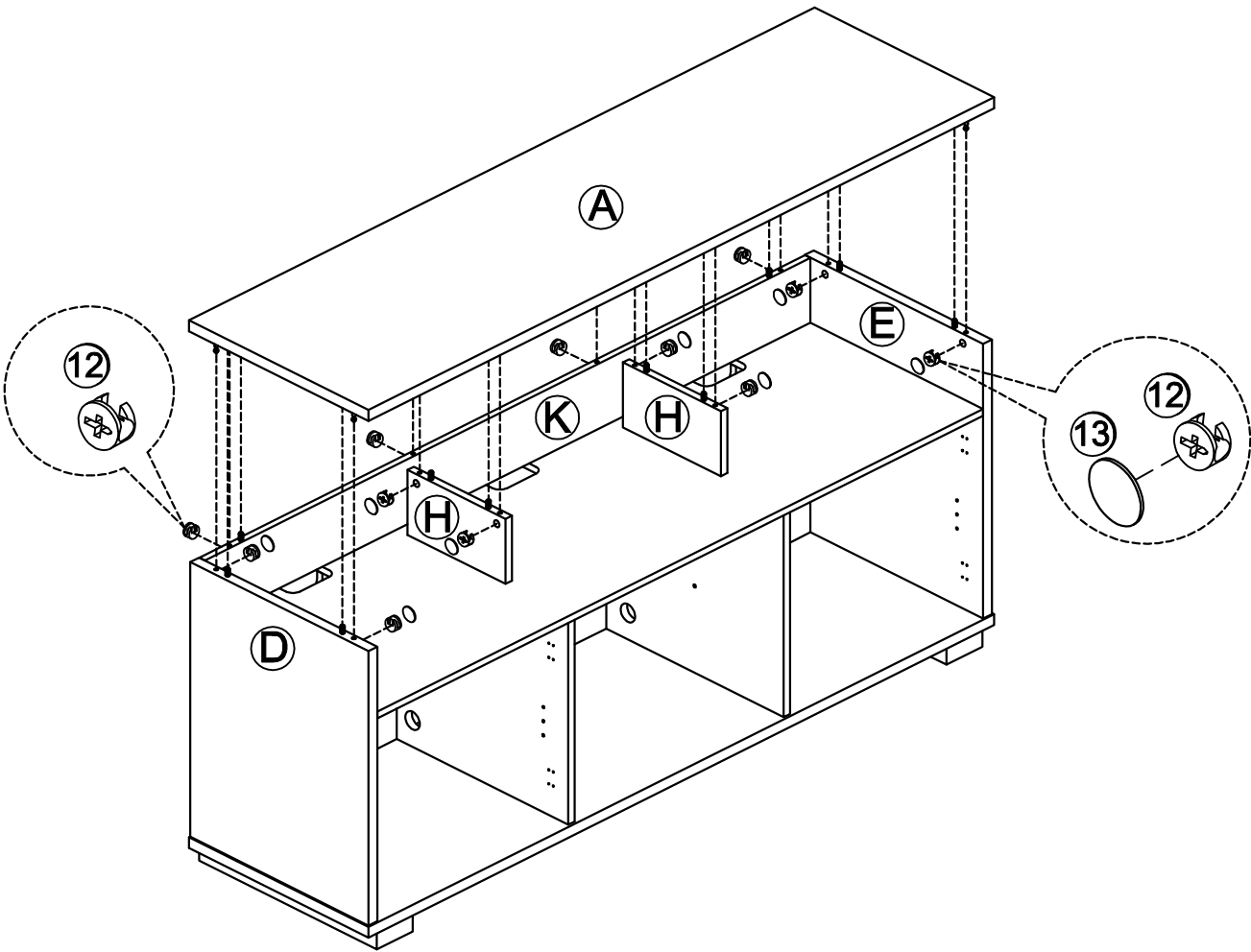

STEP 11

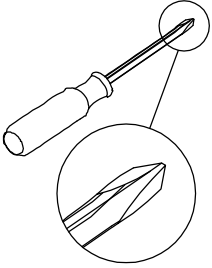
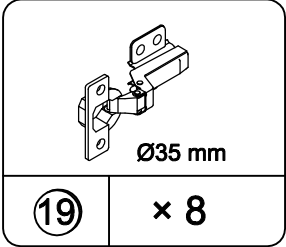
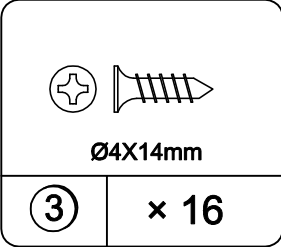

11.1 Attach (19) to (L) & (M) with (3) as illustrated.

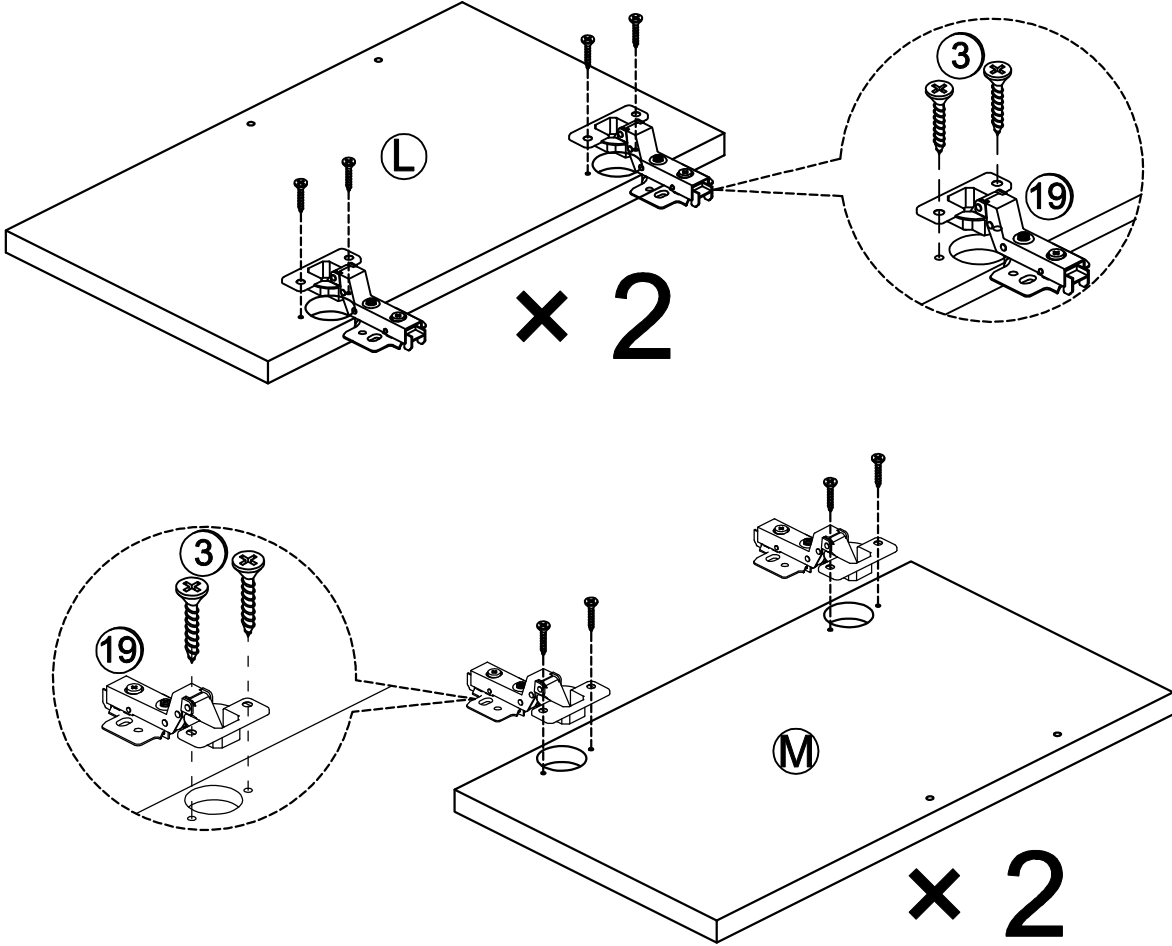

STEP 12

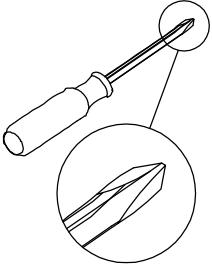
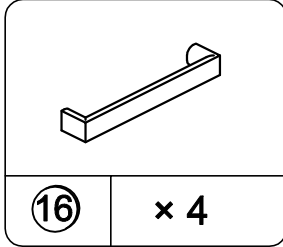
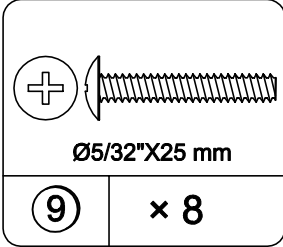
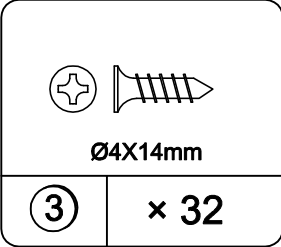

- 12.1 Attach (L) to (D) & (G) with (3) as illustrated.
- 12.2 Attach (M) to (E) & (F) with (3) as illustrated.
- 12.3 Attach (16) to (L) & (M) with (9) as illustrated.

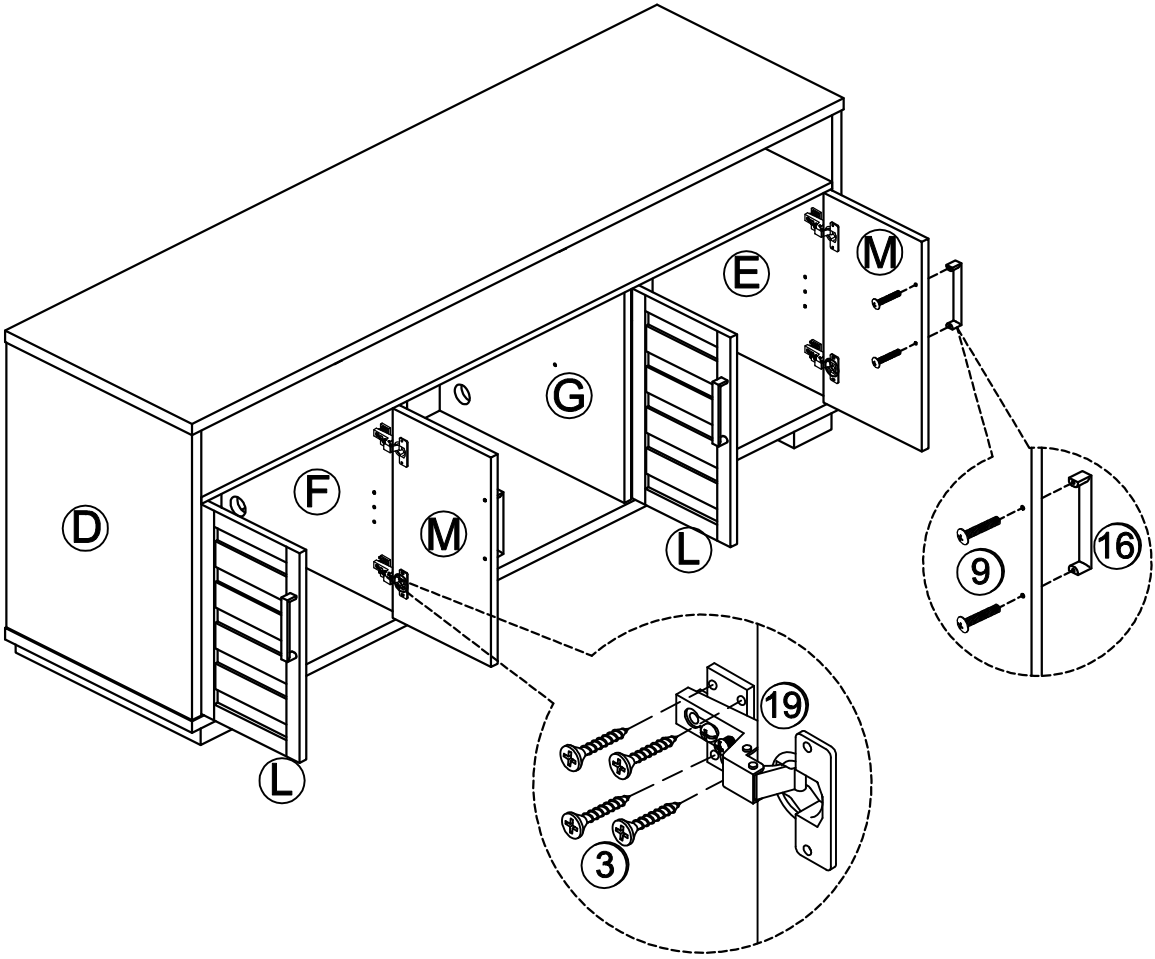

STEP 13

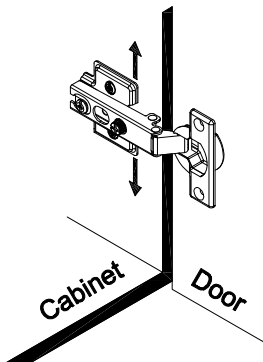
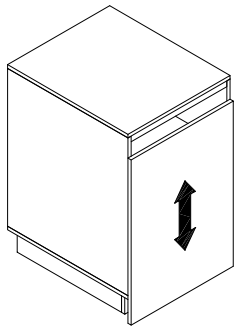
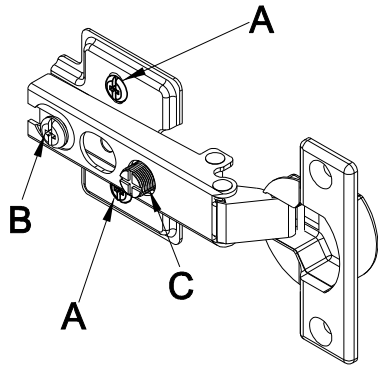

To adjust the vertical height.

Loosen the four screws "A" on both hinges. Two of them are usually in slotted holes which allows you to adjust up or down by a few mm. Then tighten back up.

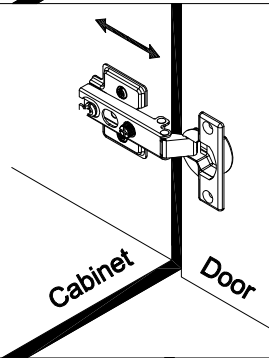
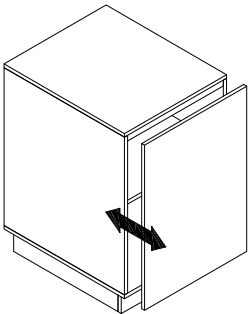

To adjust depth.

Loosen screw "B" and adjust door, if the door can not be adjusted, please loosen screw "C", then try again. Tighten screw "B" and "C".

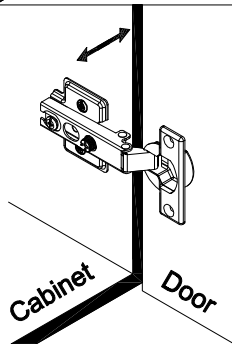
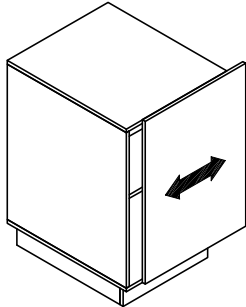

To adjust side ways.

Turning the screw "C" on BOTH hinges on each door.

STEP 14

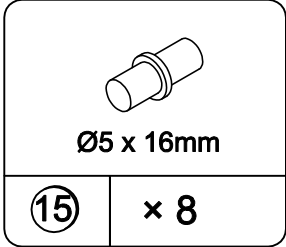

- 13.1 Insert (15) to (D), (E),(F) & (G) as illustrated.
- 13.2 Insert and put (I) on (15) as illustrated.

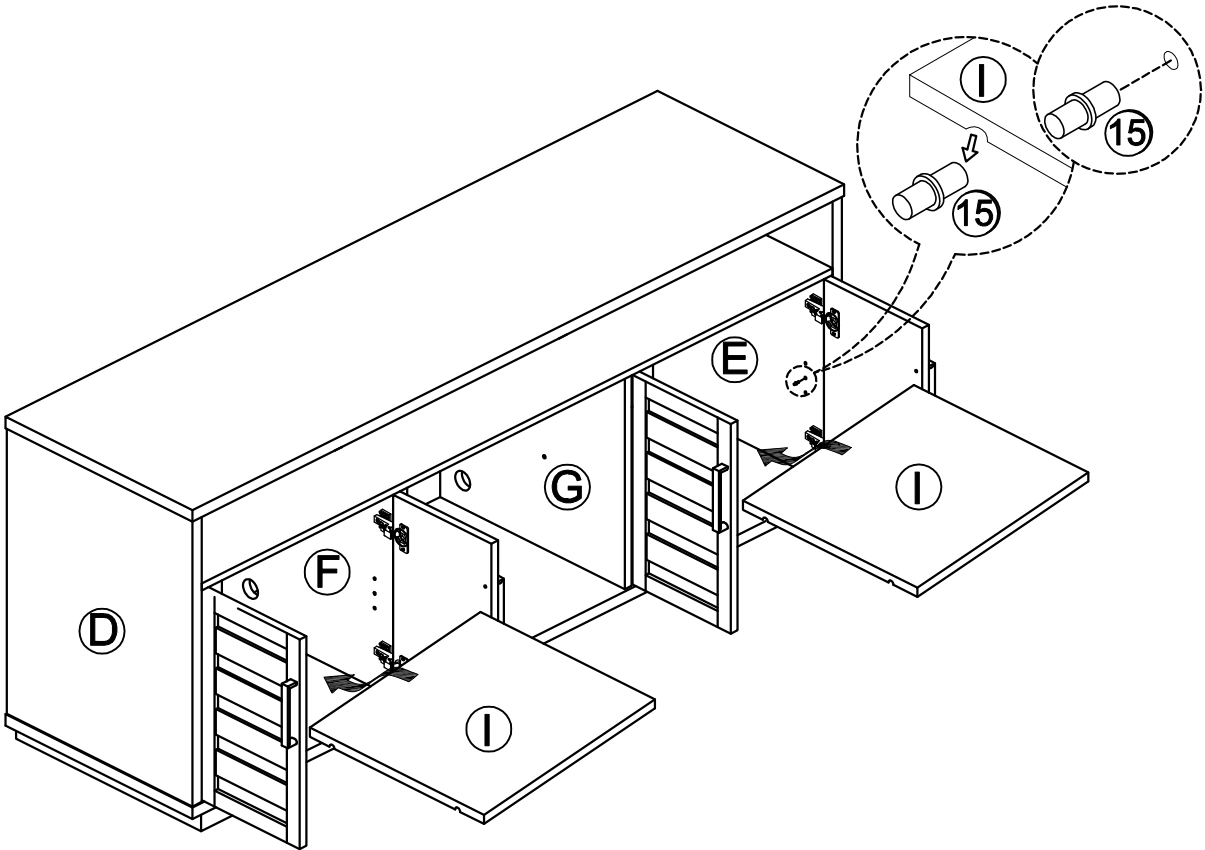

STEP 15

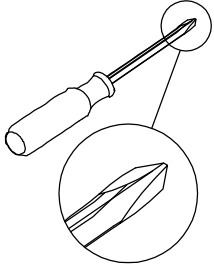
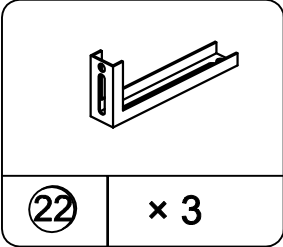
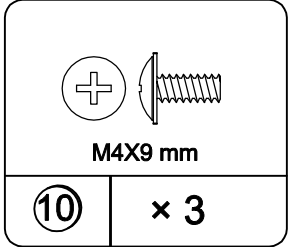
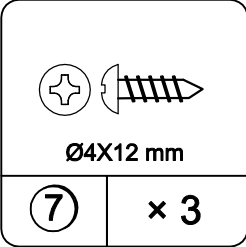

- 14.1 Insert and align fireplace front to line up with TV Stand side panels.
 - 14.2 Attach L-Brackets (22) to fireplace using bolt (10) as illustrated.
 - 14.3 Attach L-brackets to bottom and side panels using screw (7) as illustrated.
- CAUTION:** Do not tighten bolts and screw at the beginning of this assembly step. You can only fully tighten the bolts & screw gradually and evenly when all positions are corrected.

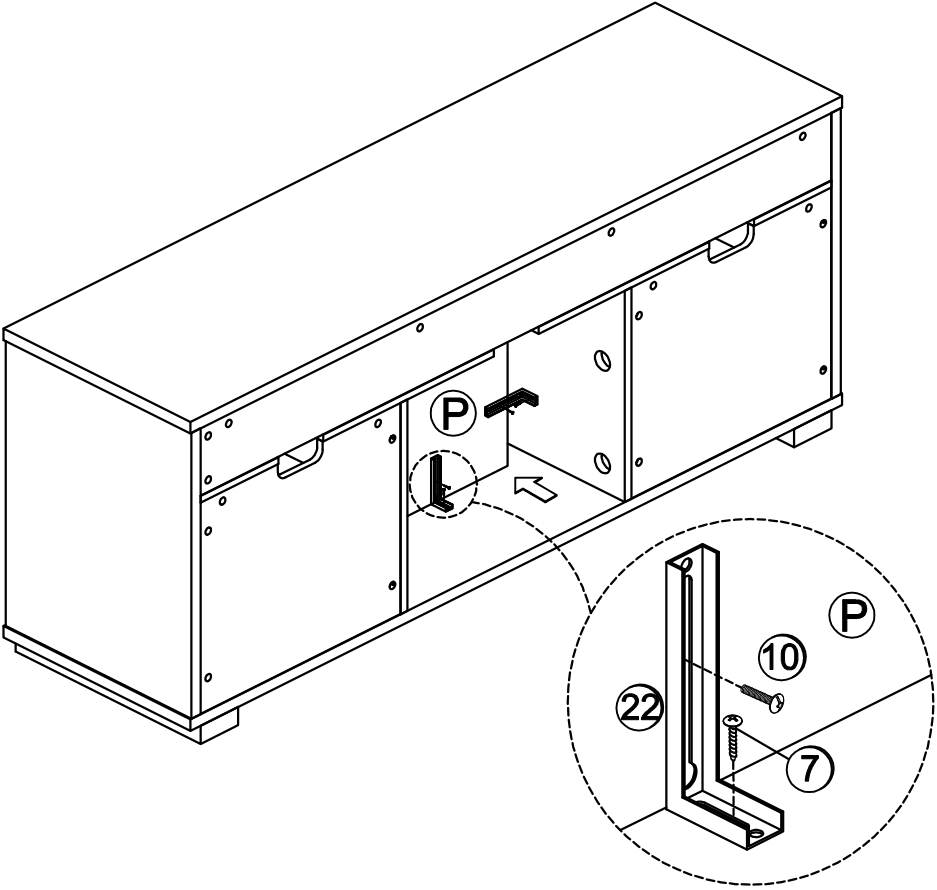

STEP 16

WARNING
If the information in the fireplace operating manual is not followed, an electric shock or fire may result in property damage, personal injury, or loss of life.

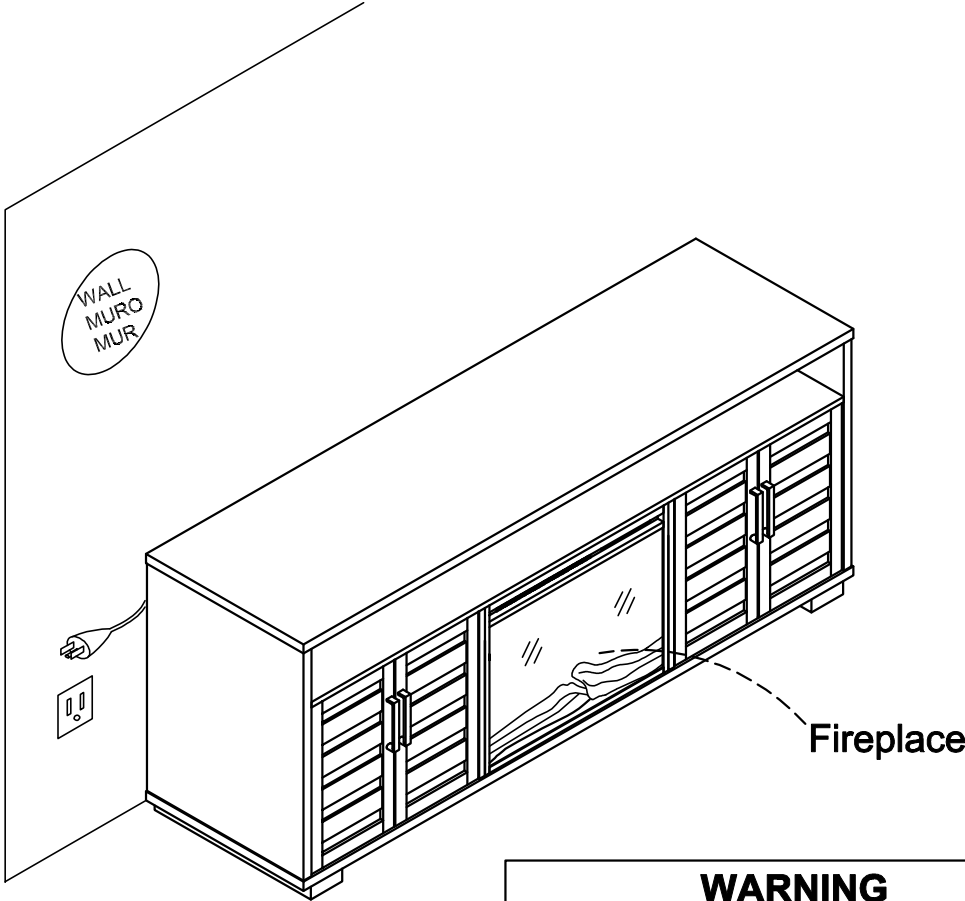

WARNING
Risk of death or serious injury.
This unit must be placed against a fixed in place wall at least as tall as television.

STEP 17

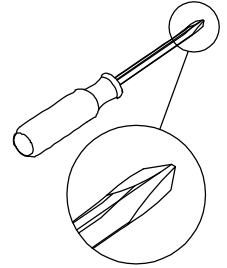
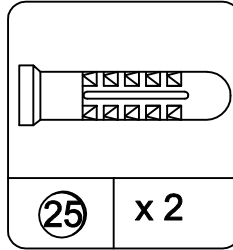
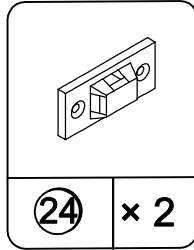
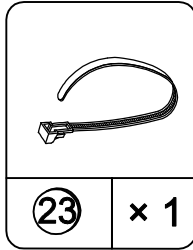
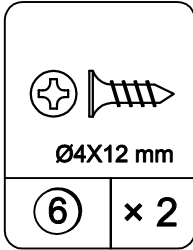
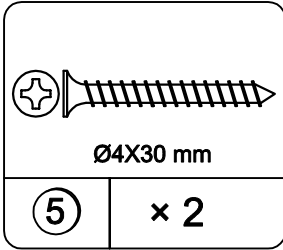

PLEASE NOTE THAT THIS UNIT MUST BE PLACED AGAINST A WALL.

Drill a 5 mm diameter hole(3/16") in the wallboard. tap the wall anchor (25) into the hole until it is flush. using screw (5) to attach the wall bracket (24) to the wallbord. using screw(6) to attach the wall bracke (24) to the top shelf back. move the furniture to its final position. thread the strap (23) through the bracket (24) as shown in the illustration,tighten strap (23) until snug. DO NOT over tighten.

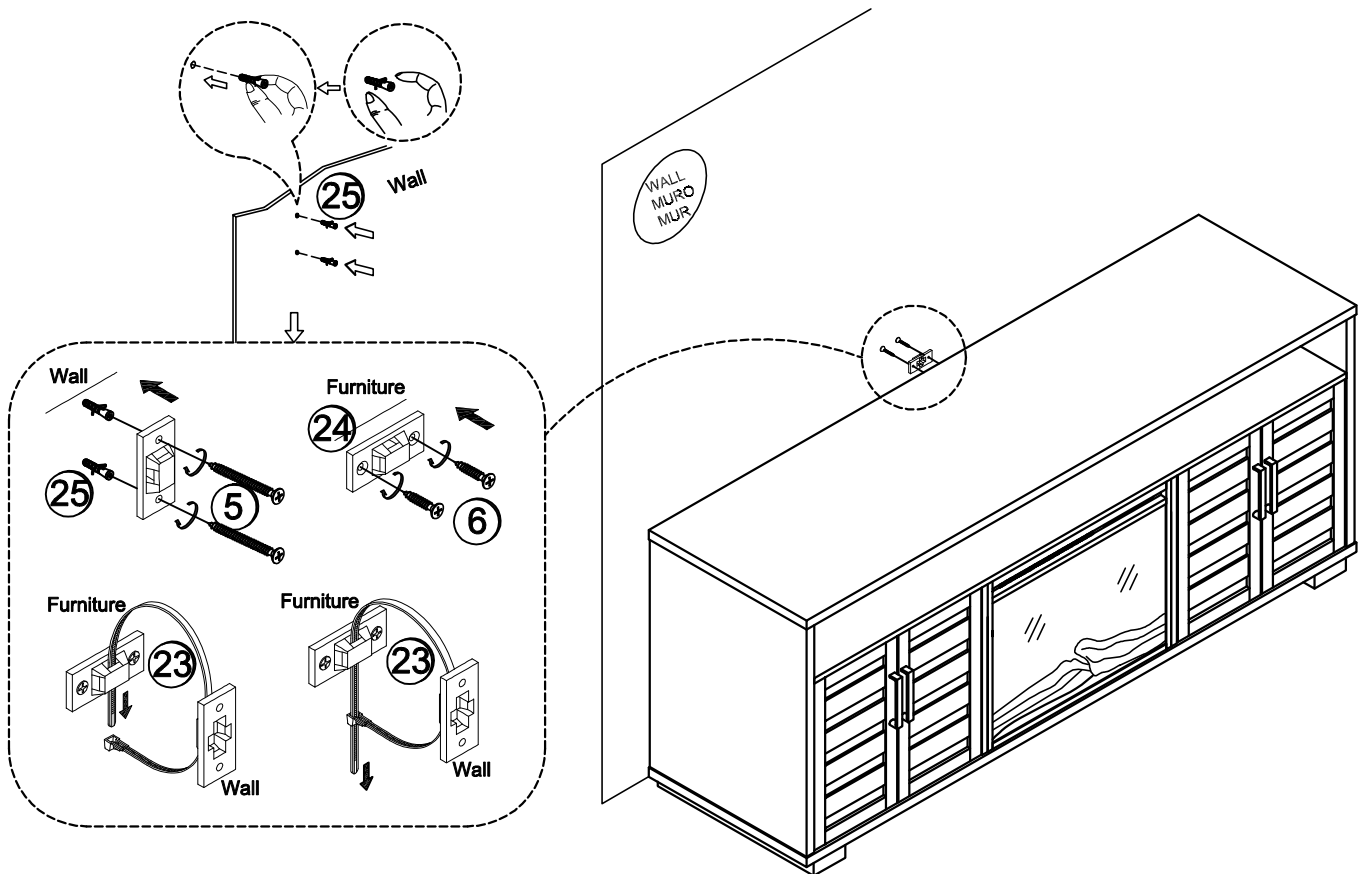

STEP 18

Apply the warning label to the center of the top panel as shown, ensure the TV covers the label in use. You will not be able to remove the label after it is applied to the top panel.

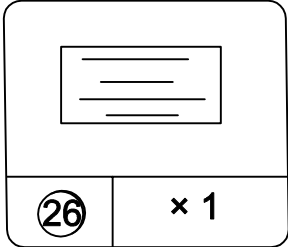

▲ WARNING
Risk of death or serious injury. This unit must be placed against a fixed in place wall at least as tall as television.

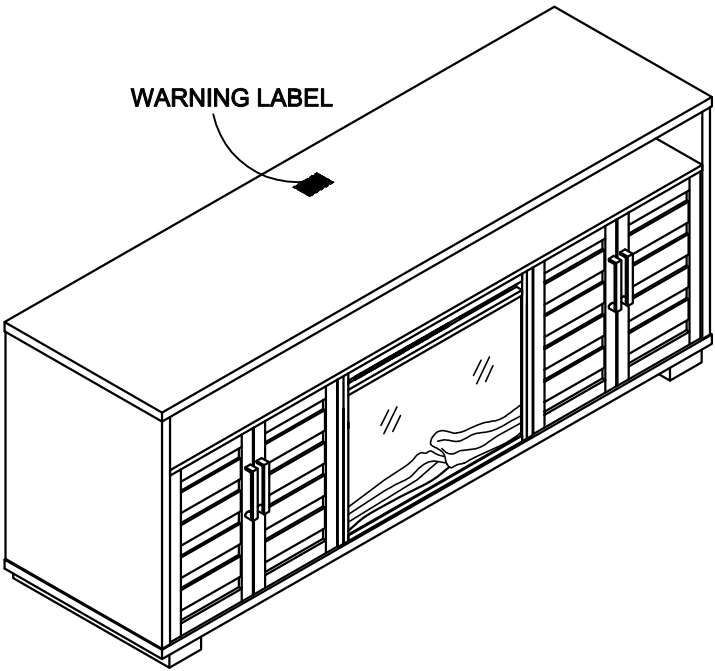

Maximum Loads

This unit has been designed to support the maximum loads shown. Exceeding these load limits could cause sagging, instability, product collapse, and/or serious injury.

Warning: Please apply the TV warning label to your unit so you'll always have the model's weight and TV size limits.

Maximum TV size: 75" flat screen, 145 Lbs/65.8 kgs.

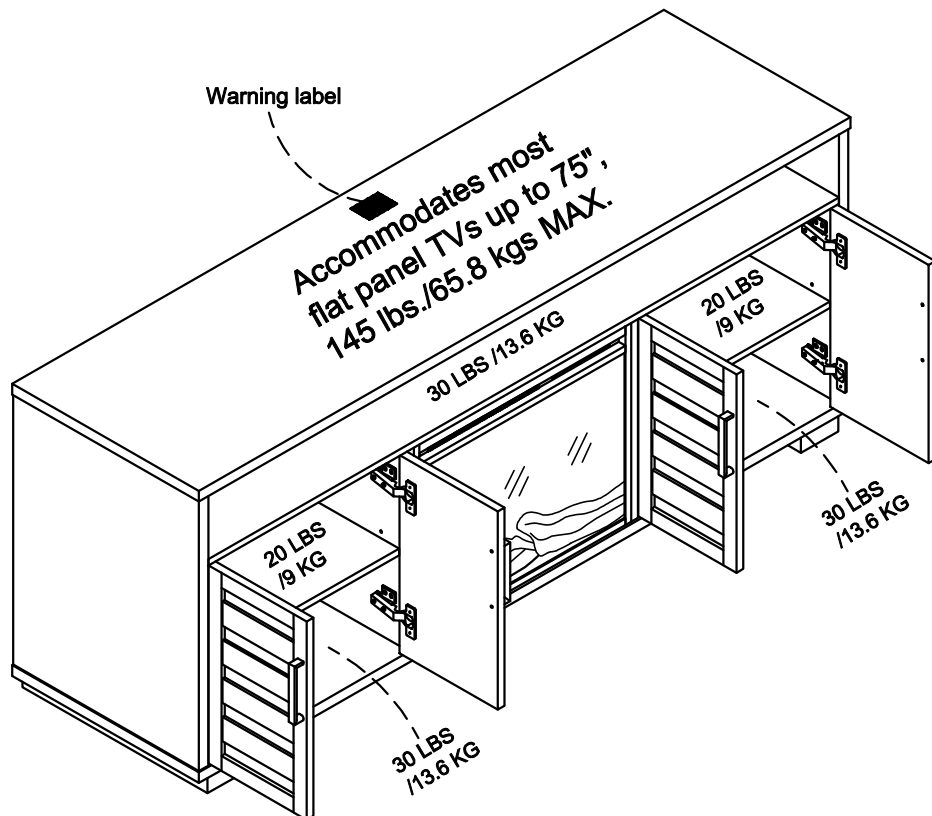

Certificate of Conformity

1. This certificate applies to the Dorel Home Furnishings, Inc. product identified by this instruction manual.
2. This certificate applies to compliance of this product with the CPSC Ban on Lead-Containing Paint (16 CFR 1303).
3. This product is distributed by: Dorel Home Furnishings, Inc.
410 East First Street South
Wright City, MO 63390
636-745-3351
4. Site of Manufacture: Svay Rieng, Cambodia
5. See front page of instruction manual for date of manufacture.

Register your product to receive the following:



- * **New trend details - sneak peek on what's new**
- * **Surveys - have a voice within our community**
- * **Exclusive deals and discount codes**
- * **Quick and easy replacement part service**

To register your product, visit ameriwoodhome.com

Star Rating



Visit your local retailer's website, rate your purchased product and leave us some feedback!

We would like to extend a big "Thank You" to all of our customers for taking the time to assemble this Ameriwood Home product, and to give us your valuable feedback.

*Thank
You!*

Español

Cubierta Delantera

Este libro de instrucciones contiene información **IMPORTANTE** de seguridad. Por favor lea y manténgalo para referencia en el futuro.

No Regrese este producto! Comuníquese con nuestro amigoso equipo de servicio al cliente para obtener ayuda.

Llámenos al: 1-800-489-3351 (Gratis) Lunes - Viernes 9am - 5pm CST

Visitar: www.ameriwoodhome.com

PRECAUCION

Este mueble puede volcarse y causar graves heridas y/o muerte.

Anclar el mueble a un poste de madera en la pared (si esto se requiere).

No Permita que los niños monten el mueble.

Mantenga los artículos más pesados en los cajones de abajo.

Consejos Útiles (página 2)

- Abra su artículo en el área donde usted planea utilizarlo para evitar levantar y moverlo menos
- Identificar, ordenar y contar las piezas antes de intentar ensamblar
- Las clavijas de compresión se golpean con un martillo
- Las diapositivas están marcadas con una R (derecha) y L (izquierda) para la colocación correcta
- Asegúrese de que siempre este el punto localizado en la parte superior de bloqueador de leva este volteado hacia borde exterior
- Utilizar todos los clavos para el panel de atrás y distribuirlos por igual
- El panel de atrás debe utilizarse para asegurarse de que la unidad quede fija y firme
- No use químicas fuertes ni limpiadores abrasivos en este artículo
- Nunca empuje, tire ni arrastre los muebles

Antes de Que Empieces (página 3)

- Lea cuidadosamente cada paso y siga el orden correcto

- Separar y contar todas sus piezas y hardware

- Dése suficiente espacio para el proceso de ensamble

- Tenga las siguientes herramientas: destornillador de cabeza plana, #2 cabeza Phillips

Destornillador y martillo

- Precaución: Si usa un taladro electrónico o un destornillador eléctrico para atornillar, por favor asegúrese que deje de atornillar cuando el tornillo este apretado. Fallar hacer esto puede causar barrer el tornillo.

Sistema de fijar el bloqueo de leva (página 3)

Esta sistema de fijar el bloqueo de leva sera usado en todo el proceso ensamble.

Identificación de los Paneles (Página 4-6)

Este no es el tamaño real

- (A) PANEL SUPERIOR
- (B) PANEL INFERIOR
- (C) ESTANTE FIJO
- (D) PANEL LATERAL IZQUIERDO
- (E) PANEL LATERAL DERECHO
- (F) PARTICIÓN INFERIOR IZQUIERDA
- (G) PARTICIÓN INFERIOR DERECHA
- (H) PARTICIÓN SUPERIOR

- (I) ESTANTE
- (J) PANEL TRASERO INFERIOR
- (K) PANEL TRASERO SUPERIOR
- (L) PUERTA IZQUIERDA
- (M) PUERTA DERECHA
- (N) PIERNA
- (O) PIERNA CENTRAL
- (P) CHIMENEA

Lista de Piezas (Página 7)

Tamaño real

- (1) Taco de madera
- (2) Tornillo
- (3) Tornillo
- (4) Tornillo
- (5) Tornillo
- (6) Tornillo
- (7) Tornillo
- (8) Perno
- (9) Perno de tornillo
- (10) Perno de tornillo
- (11) Perno de leva

Lista de Piezas (Página 8)

Este no es el tamaño real

- (12) Bloqueo de leva
- (13) Tapa de leva
- (14) Tope de puerta
- (15) Soporte de balda
- (16) Mango
- (17) Arandela
- (18) Arandela de resorte
- (19) Bisagra europea
- (20) Pegamento
- (21) Llave hexagonal
- (22) Soporte
- (23) Correa
- (24) Clip
- (25) Anclaje de pared
- (26) Etiqueta de advertencia

Página 9

1.1 Conecte (11) a (A), (D) y (E) como se ilustra.

1.2 Conecte (1) a (D) y (E) como se ilustra.

Página 10

2.1 Conecte (14) a (C) con (4) como se ilustra.

2.2 Conecte (11) a (C) como se ilustra.

2.3 Conecte (1) a (C) y (K) como se ilustra.

Página 11

3.1 Conecte (11) a (F) y (G) como se ilustra.

3.2 Conecte (1) a (F), (G), (H) y (J) como se ilustra.

Página 12

4.1 Conecte (H), (K) a (C) con (2) como se ilustra.

Página 13

5.1 Conecte (J) a (F) y (G) con (12) como se ilustra.

Página 14

6.1 Conecte (F), (G), (J) a (C) con (12) como se ilustra.

Página 15

7.1 Conecte (D) y (E) a la muestra del paso anterior con (12) como se ilustra.

Página 16

8.1 Adjunte (B) a la muestra del paso anterior con (2) como se ilustra.

Página 17

9.1 Conecte (O) a (B) como se ilustra.

9.2 Conecte (N) a (B) con (8), (18), (17) como se ilustra.

Página 18

10.1 Conecte (D), (E), (H), (K) a (A) con (12) como se ilustra.

10.2 Utilice (13) para cubrir los orificios de bloqueo de la leva como se ilustra.

Página 19

11.1 Conecte (19) a (L) y (M) con (3) como se ilustra.

Página 20

12.1 Conecte (L) a (D) y (G) con (3) como se ilustra.

12.2 Conecte (M) a (E) y (F) con (3) como se ilustra.

12.3 Conecte (16) a (L) y (M) con (9) como se ilustra.

Página 21

Ajuste de la bisagra de la puerta

Página 22

13.1 Inserte (15) en (D), (E), (F) y (G) como se ilustra.

13.2 Inserte y coloque (I) en (15) como se ilustra.

Página 23

14.1 Inserte y alinee el frente de la chimenea para alinearlos con los paneles laterales del soporte del televisor.

14.2 Fije los soportes en L (22) a la chimenea con el perno (10) como se muestra en la ilustración.

14.3 Fije los soportes en L a los paneles inferior y lateral con el tornillo (7) como se muestra en la ilustración.

PRECAUCIÓN: No apriete los pernos y atornille al comienzo de este paso de montaje. Solo puede apretar completamente los pernos y atornillar de manera gradual y uniforme cuando se corrijan todas las posiciones.

Página 24**ADVERTENCIA**

Si no se sigue la información del manual de funcionamiento de la chimenea, una descarga eléctrica o un incendio pueden provocar daños a la propiedad, lesiones personales o la muerte.

Riesgo de muerte o lesiones graves. Esta unidad debe colocarse contra una pared fija en su lugar al menos tan alta como un televisor.

Página 25

TENGA EN CUENTA QUE ESTA UNIDAD DEBE COLOCARSE CONTRA UNA PARED.

Taladre un orificio de 5 mm de diámetro (3/16 ") en el tablero de la pared. Golpee el anclaje de la pared (25) en el orificio hasta que quede nivelado. Con el tornillo (5) para fijar el soporte de pared (24) al tablero de pared. usando un tornillo para fijar el tablero. usando el tornillo (6) para fijar el soporte de pared (24) a la parte posterior del estante superior. Mueva los muebles a su posición final. Pase la correa (23) a través del soporte (24) como se muestra en la ilustración, apriete la correa (23) hasta que quede ajustada. NO apriete demasiado.

Página 26

Aplique la etiqueta de advertencia en el centro del panel superior como se muestra, asegúrese de que el televisor cubra la etiqueta en uso.

No podrá quitar la etiqueta después de que se aplique al panel superior.

Riesgo de muerte o lesiones graves. Esta unidad debe colocarse contra una pared fija en su lugar al menos tan alta como un televisor.

Página 27

CARGA MAXIMA

Esta unidad ha sido diseñada para soportar la carga máxima anotada. El exceder estos límites puede causar inestabilidad, colapsarse y/o causar serias lesiones.

ADVERTENCIA: aplique la etiqueta de advertencia de TV a su unidad para que siempre tenga los límites de peso y tamaño de TV del modelo.

Tamaño máximo del televisor: pantalla plana de 75".

Página 28

Registre su producto para recibir lo siguiente:

- * Detalles de nuevas tendencias - Vistazo a lo nuevo
- * Encuestas - alec su voz entre su comunidad
- * Códigos de ofertas y descuentos exclusivos
- * Fácil y rápido servicio de partes de remplace

Para registrar su producto, visite ameriwoodhome.com

Clasificación de 5 estrellas

Visite el sitio web de su distribuidor local, califique el producto que compró y déjenos sus comentarios.

Nos gustaría enviar un gran "Agradecimiento" a todos nuestros clientes por tomarse el tiempo de ensamblar este producto de Ameriwood Home, y por darnos sus valiosos comentarios.

Gracias

Couverture Avant

CE LIVRET D'INSTRUCTION CONTIENT DES INFORMATIONS **IMPORTANTES** SUR LA SÉCURITÉ.
VEUILLEZ LIRE ET GARDER POUR UNE RÉFÉRENCE FUTURE

Ne retournez pas ce produit! Contactez notre équipe de service à la clientèle amicale d'abord pour obtenir de l'aide.

Appelez-nous: 1-800-489-3351 (sans frais) du Lundi au Vendredi de 9h à 17h Heure Centrale

Visitez: www.ameriwoodhome.com

ATTENTION

Le meuble peut basculer et causer des blessures graves ou la mort.

Ancrer le meuble à une planche murale dans le mur (si indiqué).

Ne laissez pas les enfants grimper sur le meuble.

Placez les articles lourds sur les étagères ou dans les tiroirs inférieurs.

Astuces Utiles (page 2)

-Ouvrez votre article dans la zone que vous prévoyez de le garder pour moins de levage lourd

-Identifier, trier et compter les pièces avant d'essayer d'assembler

-Les goujons de compression sont taraudés avec un Marteau

-Les glissières sont marquées d'un R (droit) et d'un L (gauche) pour un bon placement

-Assurez-vous toujours de faire face la pointe situé sur le haut de la Serrure de Came vers le bord extérieur

-Utiliser tous les clous fournis pour le panneau arrière et les répartir également

-Le panneau arrière doit être utilisé pour vous assurer que votre appareil est robuste

-N'utilisez pas de produits chimiques agressifs ou de nettoyeurs abrasifs sur cet appareil

-Ne jamais pousser, tirer, ou faire glisser votre meuble

Avant de Commencer (page 3)

-Lisez attentivement chaque étape et suivez le bon ordre

-Séparez et comptez toutes vos pièces et matériaux

-Donnez-vous suffisamment de place pour l'assemblage

-Avoir les outils suivants: tournevis à tête plate, #2 tournevis Phillips, et Marteau

-Attention: Si vous utilisez une perceuse électrique ou un tournevis électrique pour visser, veillez à ralentir et arrêter lorsque la vis est bien serrée. Le non-respect de cette consigne peut endommager la vis.

Système de Fixation de Came (page 3)

Ce Système de Fixation de Came sera utilisé tout au long de l'assemblage

Identification des matériaux (Page 4-6)

Pas de taille réelle

- | | |
|-------------------------------|-------------------------------|
| (A) PANNEAU SUPÉRIEUR | (I) ÉTAGÈRE |
| (B) PANNEAU INFÉRIEUR | (J) PANNEAU INFÉRIEUR DU DOS |
| (C) ÉTAGÈRE FIXE | (K) PANNEAU SUPÉRIEUR ARRIÈRE |
| (D) PANNEAU LATÉRAL GAUCHE | (L) PORTE GAUCHE |
| (E) PANNEAU LATÉRAL DROIT | (M) PORTE DROITE |
| (F) CLOISON INFÉRIEURE GAUCHE | (N) JAMBE |
| (G) CLOISON INFÉRIEURE DROITE | (O) JAMBE CENTRALE |
| (H) CLOISON SUPÉRIEURE | (P) CHEMINÉE |

Liste des pièces (Page 7)

Taille réelle

- (1) Cheville en bois
- (2) Vis
- (3) Vis
- (4) Vis
- (5) Vis
- (6) Vis
- (7) Vis
- (8) Boulon
- (9) Boulon à vis
- (10) Boulon à vis
- (11) Boulon à came

Liste des pièces (Page 8)

Pas de taille réelle

- (12) Serrure à came
- (13) Couvercle de came
- (14) Butée de porte
- (15) Support d'étagère
- (16) Poignée
- (17) Rondelle
- (18) Rondelle élastique
- (19) Euro charnière
- (20) Colle
- (21) Clé hexagonale
- (22) Support
- (23) Sangle
- (24) Clip
- (25) Ancrage mural
- (26) Étiquette d'avertissement

Page 9

1.1 Fixez (11) à (A), (D) et (E) comme illustré.

1.2 Fixez (1) à (D) et (E) comme illustré.

Page 10

2.1 Fixez (14) à (C) avec (4) comme illustré.

2.2 Fixez (11) à (C) comme illustré.

2.3 Fixez (1) à (C) et (K) comme illustré.

Page 11

3.1 Fixez (11) à (F) et (G) comme illustré.

3.2 Fixez (1) à (F), (G), (H) et (J) comme illustré.

Page 12

4.1 Attachez (H), (K) à (C) avec (2) comme illustré.

Page 13

5.1 Attachez (J) à (F) et (G) avec (12) comme illustré.

Page 14

6.1 Attachez (F),(G),(J) à (C) avec (12) comme illustré.

Page 15

7.1 Attachez (D) et (E) à l'échantillon de l'étape précédente avec (12) comme illustré.

Page 16

8.1 Attachez (B) à l'échantillon de l'étape précédente avec (2) comme illustré.

Page 17

9.1 Fixez (O) à (B) comme illustré.

9.2 Fixez (N) à (B) avec (8), (18), (17) comme illustré.

Page 18

10.1 Attachez (D), (E), (H), (K) à (A) avec (12) comme illustré.

10.2 Utilisez (13) pour couvrir les trous de verrouillage à came comme illustré.

Page 19

11.1 Fixez (19) à (L) et (M) avec (3) comme illustré.

Page 20

12.1 Fixez (L) à (D) et (G) avec (3) comme illustré.

12.2 Fixez (M) à (E) et (F) avec (3) comme illustré.

12.3 Fixez (16) à (L) et (M) avec (9) comme illustré.

Page 21

Réglage des charnières de porte

Page 22

13.1 Insérez (15) à (D), (E), (F) et (G) comme illustré.

13.2 Insérez et mettez (I) sur (15) comme illustré.

Page 23

14.1 Insérez et alignez l'avant du foyer pour l'aligner avec les panneaux latéraux du meuble TV.

14.2 Fixez les supports en L (22) au foyer à l'aide du boulon (10) tel qu'illustré.

14.3 Fixez les supports en L aux panneaux inférieurs et latéraux à l'aide de la vis (7) comme illustré.

ATTENTION : Ne serrez pas les boulons et les vis au début de cette étape d'assemblage. Vous ne pouvez serrer complètement les boulons et visser que progressivement et uniformément lorsque toutes les positions sont corrigées.

Page 24

AVERTISSEMENT

Si les informations contenues dans le manuel d'utilisation du foyer ne sont pas suivies, un choc électrique ou un incendie peut entraîner des dommages matériels, des blessures corporelles ou la mort. Risque de mort ou de blessures graves. Cet appareil doit être placé contre un mur fixe au moins aussi haut que la télévision.

Page 25

VEUILLEZ NOTER QUE CET APPAREIL DOIT ÊTRE PLACÉ CONTRE UN MUR.

Percez un trou de 5 mm de diamètre (3/16") dans le panneau mural. enfoncez l'ancrage mural (25) dans le trou jusqu'à ce qu'il affleure. à l'aide de la vis (5) pour fixer le support mural (24) au panneau mural. à l'aide de vis pour fixer le panneau mural. à l'aide de la vis (6) pour fixer le support mural (24) à l'arrière de l'étagère supérieure. déplacer le meuble à sa position finale. passer la sangle (23) à travers le support (24) comme indiqué sur l'illustration, serrer la sangle (23) jusqu'à ce qu'elle soit bien ajustée. Ne pas trop serrer.

Page 26

Appliquez l'étiquette d'avertissement au centre du panneau supérieur comme indiqué, assurez-vous que le téléviseur recouvre l'étiquette en cours d'utilisation.

Vous ne pourrez pas retirer l'étiquette après l'avoir appliquée sur le panneau supérieur.

Risque de mort ou de blessures graves. Cet appareil doit être placé contre un mur fixe au moins aussi haut que la télévision.

Page 27

CHARGES MAXIMALES

Ce meuble a été conçu pour supporter les charges maximales indiquées. En excédant ces limites de charge, le meuble pourrait devenir instable, s'effondrer, et/ou causer des blessures graves.

AVERTISSEMENT: Appliquez l'étiquette d'avertissement du téléviseur sur votre appareil afin d'avoir toujours les limites de poids et de taille du téléviseur du modèle.

Taille maximale du téléviseur : écran plat 75".

Page 28

Enregistrez votre produit pour recevoir les éléments suivantes:

- * Détails sur les nouvelles tendances - un aperçu sur les nouveautés
- * Sondages - avoir une voix au sein de notre communauté
- * Offres exclusives et codes promo
- * Service de pièces de rechange rapide et facile

Pour enregistrer votre produit, visitez ameriwoodhome.com

5 Étoiles

Visitez le site Web de votre détaillant local, évaluez le produit que vous avez acheté et laissez-nous vos commentaires !

Nous tenons à offrir un grand "Merci" à tous nos clients pour avoir pris le temps d'assembler ce produit "Ameriwood Home", et de nous donner vos commentaires précieux.

Merci